

Version 1.0

Published March 2018

Copyright©2018 ASRock INC. All rights reserved.



Copyright Notice:

No part of this documentation may be reproduced, transcribed, transmitted, or translated in any language, in any form or by any means, except duplication of documentation by the purchaser for backup purpose, without written consent of ASRock Inc.

Products and corporate names appearing in this documentation may or may not be registered trademarks or copyrights of their respective companies, and are used only for identification or explanation and to the owners' benefit, without intent to infringe.

Disclaimer:

Specifications and information contained in this documentation are furnished for informational use only and subject to change without notice, and should not be construed as a commitment by ASRock. ASRock assumes no responsibility for any errors or omissions that may appear in this documentation.

With respect to the contents of this documentation, ASRock does not provide warranty of any kind, either expressed or implied, including but not limited to the implied warranties or conditions of merchantability or fitness for a particular purpose.

In no event shall ASRock, its directors, officers, employees, or agents be liable for any indirect, special, incidental, or consequential damages (including damages for loss of profits, loss of business, loss of data, interruption of business and the like), even if ASRock has been advised of the possibility of such damages arising from any defect or error in the documentation or product.



This device complies with Part 15 of the FCC Rules. Operation is subject to the following two conditions:

- (1) this device may not cause harmful interference, and
- (2) this device must accept any interference received, including interference that may cause undesired operation.

CALIFORNIA, USA ONLY

The Lithium battery adopted on this motherboard contains Perchlorate, a toxic substance controlled in Perchlorate Best Management Practices (BMP) regulations passed by the California Legislature. When you discard the Lithium battery in California, USA, please follow the related regulations in advance.

“Perchlorate Material-special handling may apply, see www.dtsc.ca.gov/hazardouswaste/perchlorate”

ASRock Website: <http://www.asrock.com>

AUSTRALIA ONLY

Our goods come with guarantees that cannot be excluded under the Australian Consumer Law. You are entitled to a replacement or refund for a major failure and compensation for any other reasonably foreseeable loss or damage caused by our goods. You are also entitled to have the goods repaired or replaced if the goods fail to be of acceptable quality and the failure does not amount to a major failure. If you require assistance please call ASRock Tel : +886-2-28965588 ext.123 (Standard International call charges apply)

The terms HDMI™ and HDMI High-Definition Multimedia Interface, and the HDMI logo are trademarks or registered trademarks of HDMI Licensing LLC in the United States and other countries.



Motherboard Layout

Top Side View

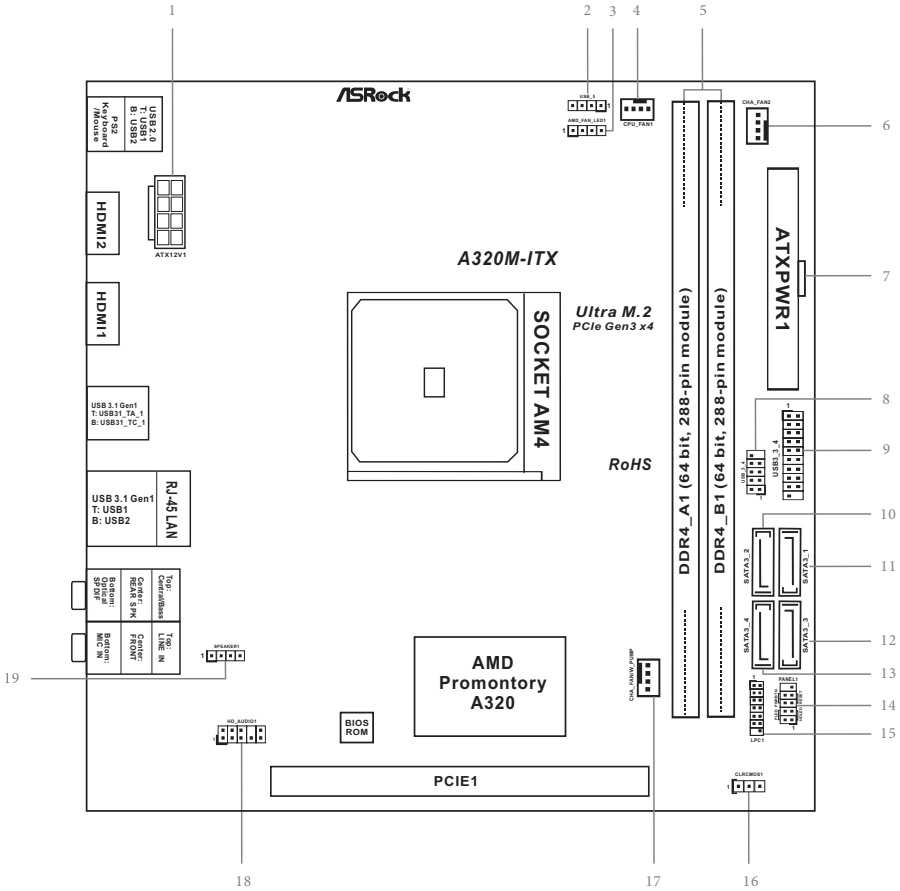

Back Side View

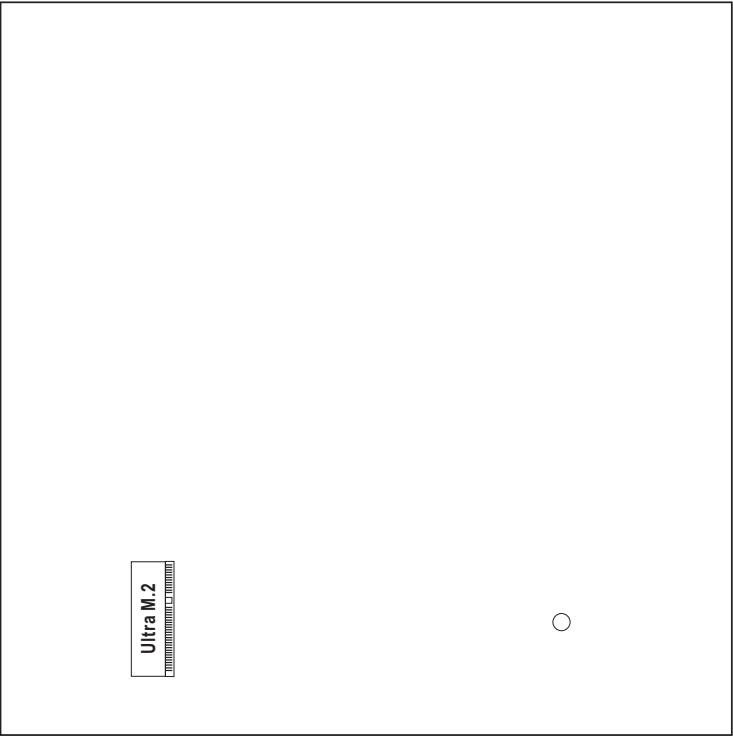

No.	Description
1	ATX 12V Power Connector (ATX12V1)
2	AMD LED Fan USB Header (USB_5)
3	AMD Fan LED Header (AMD_FAN_LED1)
4	CPU Fan Connector (CPU_FAN1)
5	2 x 288-pin DDR4 DIMM Slots (DDR4_A1, DDR4_B1)
6	Chassis Fan Connector (CHA_FAN2)
7	ATX Power Connector (ATXPWR1)
8	USB 2.0 Header (USB_3_4)
9	USB 3.1 Gen1 Header (USB3_3_4)
10	SATA3 Connector (SATA3_2)
11	SATA3 Connector (SATA3_1)
12	SATA3 Connector (SATA3_3)
13	SATA3 Connector (SATA3_4)
14	System Panel Header (PANEL1)
15	LPC Header (LPC1)
16	Clear CMOS Jumper (CLRCMOS1)
17	Chassis/Waterpump Fan Connector (CHA_FAN/W_PUMP)
18	Front Panel Audio Header (HD_AUDIO1)
19	Chassis Speaker Header (SPEAKER1)

I/O Panel

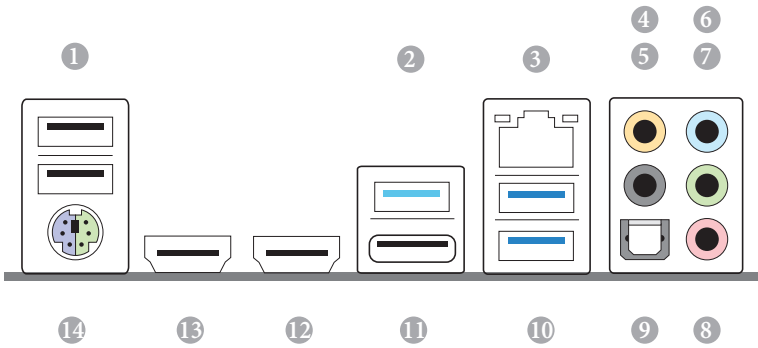

No.	Description	No.	Description
1	USB 2.0 Ports (USB_1_2)	8	Microphone (Pink)
2	USB 3.1 Gen1 Port (USB31_TA_1)	9	Optical SPDIF Out Port
3	LAN RJ-45 Port*	10	USB 3.1 Gen1 Ports (USB3_12)
4	Central / Bass (Orange)	11	USB 3.1 Gen1 Type-C Port (USB31_TC_1)
5	Rear Speaker (Black)	12	HDMI Port
6	Line In (Light Blue)	13	HDMI Port
7	Front Speaker (Lime)**	14	PS/2 Mouse/Keyboard Port

* There are two LEDs on each LAN port. Please refer to the table below for the LAN port LED indications.

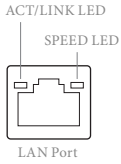

Activity / Link LED		Speed LED	
Status	Description	Status	Description
Off	No Link	Off	10Mbps connection
Blinking	Data Activity	Orange	100Mbps connection
On	Link	Green	1Gbps connection

** If you use a 2-channel speaker, please connect the speaker's plug into "Front Speaker Jack". See the table below for connection details in accordance with the type of speaker you use.

Audio Output Channels	Front Speaker (No. 7)	Rear Speaker (No. 5)	Central / Bass (No. 4)	Line In (No. 6)
2	V	--	--	--
4	V	V	--	--
6	V	V	V	--
8	V	V	V	V

Chapter 1 Introduction

Thank you for purchasing ASRock A320M-ITX motherboard, a reliable motherboard produced under ASRock's consistently stringent quality control. It delivers excellent performance with robust design conforming to ASRock's commitment to quality and endurance.



Because the motherboard specifications and the BIOS software might be updated, the content of this manual will be subject to change without notice. In case any modifications of this manual occur, the updated version will be available on ASRock's website without further notice. If you require technical support related to this motherboard, please visit our website for specific information about the model you are using. You may find the latest VGA cards and CPU support list on ASRock's website as well. ASRock website <http://www.asrock.com>.

1.1 Package Contents

- ASRock A320M-ITX Motherboard (Mini-ITX Form Factor)
- ASRock A320M-ITX Quick Installation Guide
- ASRock A320M-ITX Support CD
- 1 x I/O Panel Shield
- 2 x Serial ATA (SATA) Data Cables (Optional)
- 1 x Screw for M.2 Socket (Optional)

1.2 Specifications

- Platform**
- Mini-ITX Form Factor
 - 2oz Copper PCB

- CPU**
- Supports AMD Socket AM4 A-Series APUs (Bristol Ridge) and Ryzen Series CPUs (Summit Ridge, Raven Ridge and Pinnacle Ridge)
 - Digi Power design
 - 8 Power Phase design
 - Supports 105W Water Cooling (Pinnacle Ridge); Supports 95W Water Cooling (Summit Ridge); Supports 65W Water Cooling (Raven Ridge)

- Chipset**
- AMD Promontory A320

- Memory**
- Dual Channel DDR4 Memory Technology
 - 2 x DDR4 DIMM Slots
 - AMD Ryzen series CPUs (Pinnacle Ridge) support DDR4 3466+(OC)/3200(OC)/2933/2667/2400/2133 ECC & non-ECC, un-buffered memory*
 - AMD Ryzen series CPUs (Summit Ridge) support DDR4 3466+(OC)/3200(OC)/2933(OC)/2667/2400/2133 ECC & non-ECC, un-buffered memory*
 - AMD Ryzen series CPUs (Raven Ridge) support DDR4 3466+(OC)/3200(OC)/2933(OC)/2667/2400/2133 non-ECC, un-buffered memory*
 - AMD 7th Gen A-Series APUs support DDR4 2400/2133 ECC & non-ECC, un-buffered memory*
- * For Ryzen Series CPUs (Raven Ridge), ECC is only supported with PRO CPUs.
- * Please refer to Memory Support List on ASRock's website for more information. (<http://www.asrock.com/>)
- * Please refer to page 12 for DDR4 UDIMM maximum frequency support.
- Max. capacity of system memory: 32GB
 - 15 μ Gold Contact in DIMM Slots

Expansion Slot

AMD Ryzen series CPUs (Summit Ridge and Pinnacle Ridge)

- 1 x PCI Express 3.0 x16 Slot (PCIe1: x16 mode)*

AMD 7th A-Series APUs / Raven Ridge CPUs

- 1 x PCI Express 3.0 x16 Slot (PCIe1: x8 mode)*

* Supports NVMe SSD as boot disks

Graphics

- Integrated AMD Radeon™ Vega Series Graphics in Ryzen Series APU*
- Integrated AMD Radeon™ R-Series Graphics in A-series APU*

* Actual support may vary by CPU

- DirectX 12, Pixel Shader 5.0
- Max. shared memory 2GB
- Supports 2 x HDMI with max. resolution up to 4K x 2K (4096x2160) @ 24Hz / (3840x2160) @ 30Hz
- Supports Auto Lip Sync, Deep Color (12bpc), xvYCC and HBR (High Bit Rate Audio) with HDMI Ports (Compliant HDMI monitor is required)
- Supports HDCP with HDMI Ports
- Supports Full HD 1080p Blu-ray (BD) playback with HDMI Ports

Audio

- 7.1 CH HD Audio with Content Protection (Realtek ALC1220 Audio Codec)
- Premium Blu-ray Audio support
- Supports Surge Protection
- Nichicon Fine Gold Series Audio Caps
- 120dB SNR DAC with Differential Amplifier
- Pure Power-In
- Direct Drive Technology
- PCB Isolate Shielding
- Impedance Sensing on Line Out port
- Individual PCB Layers for R/L Audio Channel

LAN

- Gigabit LAN 10/100/1000 Mb/s
- GigaLAN Intel® I211AT
- Supports Wake-On-LAN
- Supports Lightning/ESD Protection
- Supports Energy Efficient Ethernet 802.3az
- Supports PXE

Rear Panel I/O

- 1 x PS/2 Mouse/Keyboard Port
- 2 x HDMI Ports
- 1 x Optical SPDIF Out Port
- 2 x USB 2.0 Ports (Supports ESD Protection)
- 1 x USB 3.1 Gen1 Type-A Port (Supports ESD Protection)
- 1 x USB 3.1 Gen1 Type-C Port (Supports ESD Protection)
- 2 x USB 3.1 Gen1 Ports (Supports ESD Protection)
- 1 x RJ-45 LAN Port with LED (ACT/LINK LED and SPEED LED)
- HD Audio Jacks: Rear Speaker / Central / Bass / Line in / Front Speaker / Microphone

Storage

- 4 x SATA3 6.0 Gb/s Connectors, support RAID (RAID 0, RAID 1 and RAID 10), NCQ, AHCI and Hot Plug
 - 1 x Ultra M.2 Socket, supports M Key type 2280 M.2 SATA3 6.0 Gb/s module and M.2 PCI Express module up to Gen3 x4 (32 Gb/s) (with Ryzen Series CPU) or Gen3 x2 (16 Gb/s) (with A-Series APU)*
- * Supports NVMe SSD as boot disks

Connector

- 1 x LPC Header
- 1 x AMD Fan LED Header
- * The AMD Fan LED Header supports LED strips of maximum load of 3A (36W) and length up to 2.5M.
- 1 x CPU Fan Connector (4-pin)
- * The CPU Fan Connector supports the CPU fan of maximum 1A (12W) fan power.
- 1 x Chassis Fan Connector (4-pin)
- 1 x Chassis/Water Pump Fan Connector (4-pin) (Smart Fan Speed Control)
- * The Chassis/Water Pump Fan supports the water cooler fan of maximum 1.5A (18W) fan power.
- 1 x 24 pin ATX Power Connector
- 1 x 8 pin 12V Power Connector (Hi-Density Power Connector)
- 1 x Front Panel Audio Connector
- 1 x AMD LED Fan USB Header

- 1 x USB 2.0 Header (Supports 2 USB 2.0 ports) (Supports ESD Protection)
- 1 x USB 3.1 Gen1 Header (Supports 2 USB 3.1 Gen1 ports) (Supports ESD Protection)

**BIOS
Feature**

- AMI UEFI Legal BIOS with GUI support
- Supports “Plug and Play”
- ACPI 5.1 compliance wake up events
- Supports jumperfree
- SMBIOS 2.3 support
- CPU, DRAM, PCH 1.05V, PROM 2.5V, Voltage Multi-adjustment

**Hardware
Monitor**

- Temperature Sensing: CPU, Chassis, Chassis/Water Pump Fans
- Fan Tachometer: CPU, Chassis, Chassis/Water Pump Fans
- Quiet Fan (Auto adjust chassis fan speed by CPU temperature): CPU, Chassis, Chassis/Water Pump Fans
- Fan Multi-Speed Control: CPU, Chassis, Chassis/Water Pump Fans
- Voltage monitoring: +12V, +5V, +3.3V, CPU Vcore

OS

- Microsoft® Windows® 10 64-bit

**Certifica-
tions**

- FCC, CE
- ErP/EuP ready (ErP/EuP ready power supply is required)

* For detailed product information, please visit our website: <http://www.asrock.com>



Please realize that there is a certain risk involved with overclocking, including adjusting the setting in the BIOS, applying Untied Overclocking Technology, or using third-party overclocking tools. Overclocking may affect your system's stability, or even cause damage to the components and devices of your system. It should be done at your own risk and expense. We are not responsible for possible damage caused by overclocking.

Chapter 2 Installation

This is a Mini-ITX form factor motherboard. Before you install the motherboard, study the configuration of your chassis to ensure that the motherboard fits into it.

Pre-installation Precautions

Take note of the following precautions before you install motherboard components or change any motherboard settings.

- Make sure to unplug the power cord before installing or removing the motherboard. Failure to do so may cause physical injuries to you and damages to motherboard components.
- In order to avoid damage from static electricity to the motherboard's components, NEVER place your motherboard directly on a carpet. Also remember to use a grounded wrist strap or touch a safety grounded object before you handle the components.
- Hold components by the edges and do not touch the ICs.
- Whenever you uninstall any components, place them on a grounded anti-static pad or in the bag that comes with the components.
- When placing screws to secure the motherboard to the chassis, please do not over-tighten the screws! Doing so may damage the motherboard.



Please refer to the user manual in our support CD for CPU installation procedures.

2.1 Installing Memory Modules (DIMM)

This motherboard provides two 288-pin DDR4 (Double Data Rate 4) DIMM slots, and supports Dual Channel Memory Technology.



1. For dual channel configuration, you always need to install identical (the same brand, speed, size and chip-type) DDR4 DIMM pairs.
2. It is unable to activate Dual Channel Memory Technology with only one memory module installed.
3. It is not allowed to install a DDR, DDR2 or DDR3 memory module into a DDR4 slot; otherwise, this motherboard and DIMM may be damaged.

DDR4 UDIMM Maximum Frequency Support

A-Series APUs:

UDIMM Memory Slot		Frequency
A1	B1	(Mhz)
-	SR	2400
SR	-	2400
-	DR	2400
DR	-	2400
SR	SR	2400
DR	DR	2400

Ryzen CPUs (Pinnacle Ridge):

UDIMM Memory Slot		Frequency
A1	B1	(Mhz)
-	SR	2933
SR	-	2933
-	DR	2400
DR	-	2400
SR	SR	2933
DR	DR	2400

Ryzen CPUs (Summit Ridge):

UDIMM Memory Slot		Frequency (Mhz)
A1	B1	
-	SR	2667
SR	-	2667
-	DR	2667
DR	-	2667
SR	SR	2667
DR	DR	2667

Ryzen CPUs (Raven Ridge):

UDIMM Memory Slot		Frequency (Mhz)
A1	B1	
-	SR	2933
SR	-	2933
-	DR	2667
DR	-	2667
SR	SR	2667
DR	DR	2400

SR: Single rank DIMM, 1Rx4 or 1Rx8 on DIMM module label

DR: Dual rank DIMM, 2Rx4 or 2Rx8 on DIMM module label



The DIMM only fits in one correct orientation. It will cause permanent damage to the motherboard and the DIMM if you force the DIMM into the slot at incorrect orientation.

1

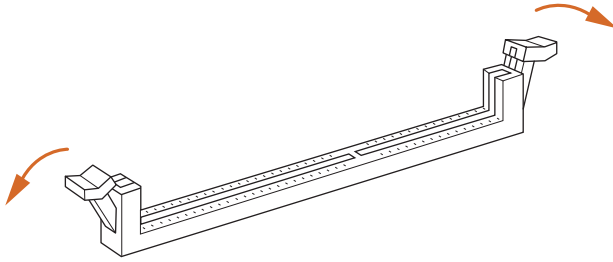

2

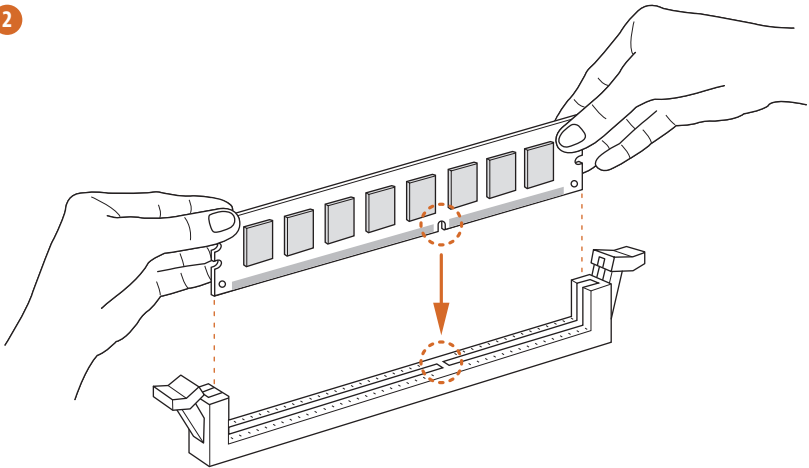

3

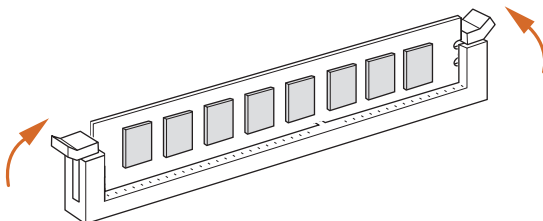

2.2 Expansion Slot (PCI Express Slot)

There is 1 PCI Express slot on the motherboard.



Before installing an expansion card, please make sure that the power supply is switched off or the power cord is unplugged. Please read the documentation of the expansion card and make necessary hardware settings for the card before you start the installation.

PCIe slot:

PCIE1 (PCIe 3.0 x16 slot) is used for PCI Express x16 lane width graphics cards.*

* PCIE1 will downgrade to x8 mode when A-Series APU / Raven Ridge CPU is installed.

2.3 Jumpers Setup

The illustration shows how jumpers are setup. When the jumper cap is placed on the pins, the jumper is “Short”. If no jumper cap is placed on the pins, the jumper is “Open”. The illustration shows a 3-pin jumper whose pin1 and pin2 are “Short” when a jumper cap is placed on these 2 pins.

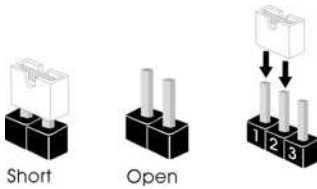

Clear CMOS Jumper
(CLRMOSE1)
(see p.1, No. 16)

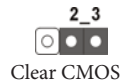

CLRMOSE1 allows you to clear the data in CMOS. To clear and reset the system parameters to default setup, please turn off the computer and unplug the power cord from the power supply. After waiting for 15 seconds, use a jumper cap to short pin2 and pin3 on CLRMOSE1 for 5 seconds. However, please do not clear the CMOS right after you update the BIOS. If you need to clear the CMOS when you just finish updating the BIOS, you must boot up the system first, and then shut it down before you do the clear-CMOS action. Please be noted that the password, date, time, and user default profile will be cleared only if the CMOS battery is removed.

2.4 Onboard Headers and Connectors



Onboard headers and connectors are NOT jumpers. Do NOT place jumper caps over these headers and connectors. Placing jumper caps over the headers and connectors will cause permanent damage to the motherboard.

System Panel Header
(9-pin PANEL1)
(see p.1, No. 14)

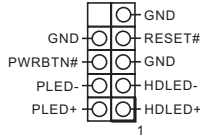

Connect the power switch, reset switch and system status indicator on the chassis to this header according to the pin assignments below. Note the positive and negative pins before connecting the cables.



PWRBTN (Power Switch):

Connect to the power switch on the chassis front panel. You may configure the way to turn off your system using the power switch.

RESET (Reset Switch):

Connect to the reset switch on the chassis front panel. Press the reset switch to restart the computer if the computer freezes and fails to perform a normal restart.

PLED (System Power LED):

Connect to the power status indicator on the chassis front panel. The LED is on when the system is operating. The LED keeps blinking when the system is in S3 sleep state. The LED is off when the system is in S4 sleep state or powered off (S5).

HDLED (Hard Drive Activity LED):

Connect to the hard drive activity LED on the chassis front panel. The LED is on when the hard drive is reading or writing data.

The front panel design may differ by chassis. A front panel module mainly consists of power switch, reset switch, power LED, hard drive activity LED, speaker and etc. When connecting your chassis front panel module to this header, make sure the wire assignments and the pin assignments are matched correctly.

Chassis Speaker Header
(4-pin SPEAKER1)
(see p.1, No. 19)

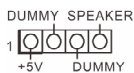

Please connect the chassis speaker to this header.

Serial ATA3 Connectors

- (SATA3_1:
see p.1, No. 11)
- (SATA3_2:
see p.1, No. 10)
- (SATA3_3:
see p.1, No. 12)
- (SATA3_4:
see p.1, No. 13)

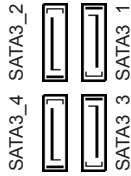

These four SATA3 connectors support SATA data cables for internal storage devices with up to 6.0 Gb/s data transfer rate.

AMD LED Fan USB Header

- (4-pin USB_5)
(see p.1, No. 2)

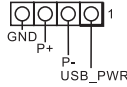

This header is used for connecting the USB connector on the AMD SR3 Heatsink.

USB 2.0 Header

- (9-pin USB_3_4)
(see p.1, No. 8)

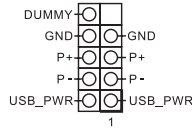

There is one header on this motherboard. Each USB 2.0 header can support two ports.

USB 3.1 Gen1 Header

- (19-pin USB3_3_4)
(see p.1, No. 9)

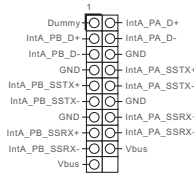

There is one header on this motherboard. Each USB 3.1 Gen1 header can support two ports.

Front Panel Audio Header

- (9-pin HD_AUDIO1)
(see p.1, No. 18)

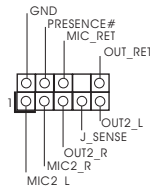

This header is for connecting audio devices to the front audio panel.



1. High Definition Audio supports Jack Sensing, but the panel wire on the chassis must support HDA to function correctly. Please follow the instructions in our manual and chassis manual to install your system.
2. If you use an AC'97 audio panel, please install it to the front panel audio header by the steps below:
 - A. Connect Mic_IN (MIC) to MIC2_L.
 - B. Connect Audio_R (RIN) to OUT2_R and Audio_L (LIN) to OUT2_L.
 - C. Connect Ground (GND) to Ground (GND).
 - D. MIC_RET and OUT_RET are for the HD audio panel only. You don't need to connect them for the AC'97 audio panel.
 - E. To activate the front mic, go to the "FrontMic" Tab in the Realtek Control panel and adjust "Recording Volume".

Chassis Fan Connector
(4-pin CHA_FAN2)
(see p.1, No. 6)

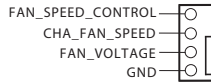

Please connect fan cables to the fan connectors and match the black wire to the ground pin.

Chassis/Water Pump Fan Connector
(4-pin CHA_FAN/W_PUMP)
(see p.1, No. 17)

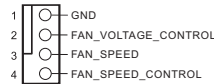

This motherboard provides a 4-Pin water cooling chassis fan connector. If you plan to connect a 3-Pin chassis water cooler fan, please connect it to Pin 1-3.

CPU Fan Connector
(4-pin CPU_FAN1)
(see p.1, No. 4)

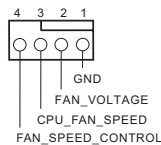

This motherboard provides a 4-Pin CPU fan (Quiet Fan) connector. If you plan to connect a 3-Pin CPU fan, please connect it to Pin 1-3.

ATX Power Connector
(24-pin ATXPWR1)
(see p.1, No. 7)

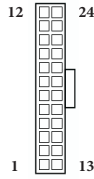

This motherboard provides a 24-pin ATX power connector. To use a 20-pin ATX power supply, please plug it along Pin 1 and Pin 13.

ATX 12V Power Connector
(8-pin ATX12V1)
(see p.1, No. 1)

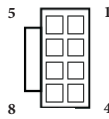

This motherboard provides a 8-pin ATX 12V power connector. To use a 4-pin ATX power supply, please plug it along Pin 1 and Pin 5.

AMD FAN LED Header
(4-pin AMD_FAN_LED1)
(see p.1, No. 3)



AMD FAN LED Header is used to connect RGB LED extension cable that comes with AMD heatsink. The cable connection allows users to choose from various LED lighting effects.

Caution: Never install the FAN LED cable in the wrong orientation; otherwise, the cable may be damaged.

Technische Daten

Plattform

- Mini-ITX-Formfaktor
- Platine mit zwei Unzen Kupfergehalt

Prozessor

- Unterstützt AMD-Sockel-AM4-APUs der A-Serie (Bristol Ridge) und Prozessoren der Ryzen-Serie (Summit Ridge, Raven Ridge und Pinnacle Ridge)
- Digi Power design
- 8-Leistungsphasendesign
- Unterstützt 105-W-Wasserkühlung (Pinnacle Ridge); unterstützt 95-W-Wasserkühlung (Summit Ridge); unterstützt 65-W-Wasserkühlung (Raven Ridge)

Chipsatz

- AMD Promontory A320

Speicher

- Dualkanal-DDR4-Speichertechnologie
 - 2 x DDR4-DIMM-Steckplätze
 - Prozessoren der AMD-Ryzen-Serie (Pinnacle Ridge) unterstützen DDR4 3466+(OC)/3200(OC)/2933/2667/2400/2133 ECC und non-ECC, ungepufferter Speicher*
 - Prozessoren der AMD-Ryzen-Serie (Summit Ridge) unterstützen DDR4 3466+(OC)/3200(OC)/2933(OC)/2667/2400/2133 ECC und non-ECC, ungepufferter Speicher*
 - Prozessoren der AMD-Ryzen-Serie (Raven Ridge) unterstützen DDR4 3466+(OC)/3200(OC)/2933(OC)/2667/2400/2133 ECC und non-ECC, ungepufferter Speicher*
 - APU von AMDs A-Serie der 7. Generation unterstützen DDR4 2400/2133 ECC und non-ECC, ungepufferter Speicher*
- * Für Prozessoren der Ryzen-Serie (Raven Ridge), ECC wird nur mit PRO-Prozessoren unterstützt.
- * Weitere Informationen finden Sie in der Speicherkompatibilitätsliste auf der ASRock-Webseite. (<http://www.asrock.com/>)
- Systemspeicher, max. Kapazität: 32 GB
 - 15-µ-Goldkontakt in DIMM-Steckplätze

Erweiterungssteckplatz

Prozessoren der AMD-Ryzen-Serie (Summit Ridge und Pinnacle Ridge)

- 1 x PCI-Express 3.0-x16-Steckplatz (PCIe1:x16-Modus)*

APUs von AMDs A-Serie der 7. Generation / Raven Ridge

- 1 x PCI-Express 3.0-x16-Steckplatz (PCI-E1:x8-Modus)*

* Unterstützt NVMe-SSD als Bootplatte

Grafikkarte

- Integrierte Grafikkarte der AMD-Radeon™-Vega-Serie in APU der Ryzen-Serie*
- Integrierte Grafikkarte der AMD-Radeon™-R-Serie in APU der A-Serie*

* Tatsächliche Unterstützung kann je nach Prozessor variieren

- DirectX 12, Pixel Shader 5.0
- Max. geteilter Speicher 2GB
- Unterstützt 2 x HDMI mit maximaler Auflösung von 4K x 2K (4096 x 2160) bei 24 Hz / (3840 x 2160) bei 30 Hz
- Unterstützt Auto-Lippensynchronizität, hohe Farbtiefe (12 bpc), xvYCC und HBR (Audio mit hoher Bitrate) mit HDMI-Ports (konformer HDMI-Monitor erforderlich)
- Unterstützt HDCP mit HDMI-Ports
- Unterstützt Blu-ray- (BD) Wiedergabe (Full HD/1080p) mit HDMI-Ports

Audio

- 7.1-Kanal-HD-Audio mit Inhaltsschutz (Realtek ALC1220-Audiocodec)
- Erstklassige Blu-ray-Audiounterstützung
- Unterstützt Überspannungsschutz
- Nichicon-Audiokappen der Fine Gold-Serie
- 120-dB-SRV-DAC mit Differentialverstärker
- Reiner Stromeingang
- Direct Drive Technology
- PCB-isolierte Abschirmung
- Impedanzerkennung am Line-Ausgang
- Individuelle PCB-Layer für rechten/linken Audiokanal

LAN

- Gigabit LAN 10/100/1000 Mb/s
- GigaLAN Intel® I211AT
- Unterstützt Wake-On-LAN
- Unterstützt Schutz gegen Blitzschlag/elektrostatische Entladung
- Unterstützt energieeffizientes Ethernet 802.3az
- Unterstützt PXE

Rückblende, E/A

- 1 x PS/2-Maus-/Tastaturanschluss
- 2 x HDMI-Port
- 1 x Optischer SPDIF-Ausgang

- 2 x USB-2.0-Ports (unterstützt Schutz gegen elektrostatische Entladung)
- 1 x USB-3.1-Gen1-Typ-A-Port (unterstützt Schutz gegen elektrostatische Entladung)
- 1 x USB-3.1-Gen1-Typ-C-Port (unterstützt Schutz gegen elektrostatische Entladung)
- 2 x USB-3.1-Gen1-Ports (unterstützt Schutz gegen elektrostatische Entladung)
- 1 x RJ-45-LAN-Port mit LED (Aktivität/Verbindung-LED und Geschwindigkeit-LED)
- HD-Audioanschlüsse: Hintere Lautsprecher / Zentral / Bass / Line-in / Vorderer Lautsprecher / Mikrofon

Speicher

- 4 x SATA-III-6,0-Gb/s-Anschlüsse, unterstützt RAID (RAID 0, RAID 1 und RAID 10), NCQ, AHCI und Hot-Plugging
- 1 x Ultra-M.2-Sockel, unterstützt M-Key-Typ-2280-M.2-SATA-III-6,0-Gb/s-Modul und M.2-PCI-Express-Modul bis Gen3 x 4 (32 Gb/s) (mit Ryzen-CPU) oder Gen3 x2 (16 Gb/s) (mit APU der A-Serie)*

* Unterstützt NVMe-SSD als Bootplatte

Anschluss

- 1 x LPC-Stiftleiste
 - 1 x AMD-Lüfter-LED-Stiftleiste
- * Die LED-Stiftleiste des AMD-Lüfters unterstützt LED-Streifen mit einer maximalen Last von 3 A (36 W) und einer Länge von bis zu 2,5 m.
- 1 x CPU-Lüfteranschluss (4-polig)
- * Der CPU-Lüfteranschluss unterstützt einen CPU-Lüfter mit einer maximalen Lüfterleistung von 1 A (12 W).
- 1 x Gehäuselüfteranschluss (4-polig)
 - 1 x Anschluss für Gehäuse-/Wasserpumpenlüfter (4-polig) (intelligente Lüftergeschwindigkeitssteuerung)
- * Der Gehäuse-/Wasserpumpenlüfter unterstützt einen Wasserkühlerlüfter mit einer maximalen Lüfterleistung von 1,5 A (18 W).
- 1 x 24-poliger ATX-Netzanschluss
 - 1 x 8-poliger 12-V-Netzanschluss (hochdichter Netzanschluss)
 - 1 x Audioanschluss an Frontblende
 - 1 x AMD-LED-Lüfter-USB-Stiftleiste
 - 1 x USB 2.0-Stiftleiste (unterstützt zwei USB 2.0-Ports) (unterstützt Schutz gegen elektrostatische Entladung)
 - 1 x USB-3.1-Gen1-Stiftleiste (unterstützt zwei USB-3.1-Gen1-Ports) (unterstützt Schutz gegen elektrostatische Entladung)

Betriebssystem

- Microsoft® Windows® 10, 64 Bit

Spécifications

- Plateforme**
- Facteur de forme Mini-ITX
 - PCB cuivre 2 onces

- Processeur**
- Prend en charge les APU série A (Bristol Ridge) et les CPU série Ryzen (Summit Ridge, Raven Ridge et Pinnacle Ridge) AM4 à socket AMD
 - Digi Power design
 - Alimentation à 8 phases
 - Prend en charge le refroidissement par eau 105 W (Pinnacle Ridge) ; Prend en charge le refroidissement par eau 95 W (Summit Ridge) ; Prend en charge le refroidissement par eau 65 W (Raven Ridge)

- Chipset**
- AMD Promontory A320

- Mémoire**
- Technologie mémoire double canal DDR4
 - 2 x fentes DIMM DDR4
 - Les processeurs AMD série Ryzen (Pinnacle Ridge) prennent en charge les mémoires sans tampon* ECC et non ECC DDR4 3466+(OC)/3200 (OC)/2933/2667/2400/2133
 - Les processeurs AMD série Ryzen (Summit Ridge) prennent en charge les mémoires sans tampon* ECC et non ECC DDR4 3466+(OC)/3200 (OC)/2933(OC)/2667/2400/2133
 - Les processeurs AMD série Ryzen (Raven Ridge) prennent en charge les mémoires sans tampon* non ECC DDR4 3466+(OC)/3200 (OC)/2933(OC)/2667/2400/2133
 - Les APU AMD série A de 7^{ème} génération prennent en charge les mémoires sans tampon* ECC et non ECC DDR4 2400/2133
- * Sur les processeurs série Ryzen (Raven Ridge), ECC est pris en charge uniquement avec les processeurs PRO.
- * Veuillez consulter la liste de prise en charge des mémoires sur le site Web d'ASRock pour de plus amples informations. (<http://www.asrock.com/>)
- Capacité max. de la mémoire système : 32Go
 - Contacts dorés 15µ sur fentes DIMM

- Fente d'expansion**
- Processeurs AMD série Ryzen (Summit Ridge et Pinnacle Ridge)**

- 1 x fente PCI Express 3.0 x 16 (PCIE1 :mode x16)*
- APU AMD série A de 7^{ème} génération (Raven Ridge)**
- 1 x fente PCI Express 3.0 x 16 (PCIE1 :mode x8)*

* Prend en charge les SSD NVMe comme disques de démarrage

Graphiques

- Carte graphique AMD Radeon™ série Vega intégrée dans APU série Ryzen*
- Carte graphique AMD Radeon™ série R intégrée dans APU série A*

* La prise en charge réelle peut varier selon le processeur

- DirectX 12, Pixel Shader 5.0
- Mémoire partagée max. 2 Go
- Prend en charge 2 x HDMI avec résolution maximale de 4K × 2K (4096x2160) @ 24Hz / (3840x2160) @ 30Hz
- Prend en charge les technologies Auto Lip Sync, Deep Color (12bpc), xvYCC et HBR (High Bit Rate Audio) avec ports HDMI (un écran compatible HDMI est requis)
- Prend en charge HDCP via ports HDMI
- Prend en charge la lecture Blu-ray (BD) Full HD 1080p via ports HDMI

Audio

- Audio 7.1 CH HD avec protection du contenu (codec audio Realtek ALC1220)
- Compatible audio Blu-ray Premium
- Prend en charge la protection contre les surtensions
- Couvercles audio série en or fin Nichicon
- 120dB SNR DAC avec amplificateur différentiel
- Entrée d'alimentation Pure Power
- Technologie Direct Drive
- Blindage isolant PCB
- Détection d'impédance sur le port de sortie ligne
- Couches de PCB individuelles pour canal audio D/G

Réseau

- Gigabit LAN 10/100/1000 Mo/s
- GigaLAN Intel® I211AT
- Prend en charge la fonction Wake-On-LAN
- Prend en charge la protection contre la foudre/les décharges électrostatiques
- Prend en charge la fonction d'économie d'énergie Ethernet 802.3az
- Prend en charge PXE

Connectique du panneau arrière

- 1 x port souris/clavier PS/2
- 2 x ports HDMI
- 1 x port sortie optique SPDIF
- 2 x ports USB 2.0 (Protection contre les décharges électrostatiques)
- 1 x port USB 3.1 Gen1 type A (Protection contre les décharges électrostatiques)
- 1 x port USB 3.1 Gen1 type C (Protection contre les décharges électrostatiques)

- 2 x ports USB 3.1 Gen1 (Protection contre les décharges électrostatiques)
- 1 x port RJ-45 LAN avec LED (LED ACT/LIEN et LED VITESSE)
- Connecteurs jack audio HD : Haut-parleur arrière / central / basses / entrée ligne / haut-parleur avant / microphone

Stockage

- 4 x connecteurs SATA3 6,0 Gbit/s, prise en charge de RAID (RAID 0, RAID 1 et RAID 10), NCQ, AHCI et branchement à chaud
- 1 x socket Ultra M.2, prend en charge les modules M.2 SATA3 6,0 Go/s type 2280 touche M et M.2 PCI Express jusqu'à Gen3 x4 (32 Go/s) (avec CPU Ryzen) ou Gen3 x2 (16 Go/s) (avec APU série A)*

* Prend en charge les SSD NVMe comme disques de démarrage

Connecteur

- 1 x embase LPC
- 1 x embase LED de ventilateur AMD

* L'embase LED de ventilateur AMD prend en charge les rubans LED d'une charge maximale de 3 A (36 W) et d'une longueur maximale de 2,5 m.

- 1 x connecteur pour ventilateur de CPU (4 broches)

* Le connecteur pour ventilateur de CPU prend en charge un ventilateur de CPU d'une puissance maximale de 1 A (12 W).

- 1 x connecteur pour ventilateur de châssis (4 broches)
- 1 x connecteur pour ventilateur de châssis/pompe à eau (4 broches) (contrôle de vitesse de ventilateur intelligent)

* Le ventilateur de châssis/pompe à eau prend en charge un ventilateur de refroidisseur d'eau d'une puissance maximale de 1,5 A (18 W).

- 1 x connecteur d'alimentation ATX 24 broches
- 1 x connecteur d'alimentation 12 V 8 broches (connecteur d'alimentation haute densité)
- 1 x connecteur audio panneau frontal
- 1 x embase USB de ventilateur LED AMD
- 1 x embase USB 2.0 (2 ports USB 2.0 pris en charge) (Protection contre les décharges électrostatiques)
- 1 x embase USB 3.1 Gen1 (2 ports USB 3.1 Gen1 pris en charge) (Protection contre les décharges électrostatiques)

Système d'exploitation

- Microsoft® Windows® 10 64 bits

Specifiche

Piattaforma

- Fattore di forma Mini-ITX
- PCB 2oz rame

CPU

- Supporta APU serie A (Bristol Ridge) e CPU serie Ryzen (Summit Ridge, Raven Ridge e Pinnacle Ridge) AMD Socket AM4
- Digi Power design
- Potenza a 8 fasi
- Supporto di raffreddamento ad acqua 105W (Pinnacle Ridge); supporto di raffreddamento ad acqua 95W (Summit Ridge); supporto di raffreddamento ad acqua 65W (Raven Ridge)

Chipset

- AMD Promontory A320

Memoria

- Tecnologia memoria DDR4 Dual Channel
 - 2 x alloggi DIMM DDR4
 - CPU serie AMD Ryzen (Pinnacle Ridge) supporto di memoria un-buffered* DDR4 3466+(OC)/3200(OC)/2933/2667/2400/2133 ECC e non-ECC
 - CPU serie AMD Ryzen (Summit Ridge) supporto di memoria un-buffered* DDR4 3466+(OC)/3200(OC)/2933/2667/2400/2133 ECC e non-ECC
 - CPU serie AMD Ryzen (Raven Ridge) supporto di memoria un-buffered* DDR4 3466+(OC)/3200(OC)/2933/2667/2400/2133 ECC e non-ECC
 - Le APU serie AMD 7^a Gen A supportano DDR4 2400/2133 ECC e non ECC, senza buffer*
- * Per le CPU serie Ryzen (Raven Ridge), è supportata solo la memoria ECC senza CPU PRO.
- * Per maggiori informazioni fare riferimento all'elenco dei supporti di memoria sul sito di ASRock. (<http://www.asrock.com/>)
- Capacità max. della memoria di sistema: 32 GB
 - Contatti d'oro 15µ negli alloggi DIMM

Alloggio d'espansione

CPU serie AMD Ryzen (Summit Ridge e Pinnacle Ridge)

- 1 x alloggiamento PCI Express 3.0 x16 (PCIe1:modalità x16)*

APU serie AMD 7th A / Raven Ridge

- 1 x alloggiamento PCI Express 3.0 x16 (PCIe1:modalità x8)*

* Supporto di SSD NVMe come disco d'avvio

Grafica

- Grafica AMD Radeon™ serie Vega integrata nelle APU serie Ryzen*
- Grafica AMD Radeon™ serie R in APU serie A*

* Il supporto effettivo può variare in base alla CPU

- DirectX 12, Pixel Shader 5.0
- Memoria condivisa max. 2GB
- Supporta 2 xHDMI con risoluzione massima fino a 4K x 2K (4096x2160) a 24Hz / (3840x2160) a 30Hz
- Supporto delle funzioni Auto Lip Sync, Deep Color (12bpc), xvYCC e HBR (High Bit Rate Audio) con porte HDMI (è necessario un monitor compatibile HDMI)
- Supporta HDCP con porte HDMI
- Supporto di riproduzione Full HD 1080p Blu-ray (BD) con la porte HDMI

Audio

- Audio HD a 7.1 canali con Content Protection (codec audio Realtek ALC1220)
- Supporto audio Blu-ray Premium
- Supporta protezione da sovratensione
- Cappucci audio Nichicon serie Fine Gold
- 120dB SNR DAC con amplificatore differenziale
- Ingresso Pure Power
- Tecnologia Direct Drive
- Schermatura isolata PCB
- Sensore impedenza sulla porta di uscita linea
- Layer PCB individuali per canali audio R/L

LAN

- LAN Gigabit 10/100/1000 Mb/s
- GigaLAN Intel® I211AT
- Supporto WOL (Wake-On-LAN)
- Supporta protezione da fulmini/scariche elettrostatiche
- Supporto Energy Efficient Ethernet 802.3az
- Supporto PXE

I/O pannello posteriore

- 1 x porta mouse/tastiera PS/2
- 2 x porte HDMI
- 1 x porta uscita SPDIF ottico
- 2 x porte USB 2.0 (supporta protezione da scariche elettrostatiche)
- 1 x Porta USB 3.1 Gen1 di tipo A (supporta protezione da scariche elettrostatiche)

- 1 x Porta USB 3.1 Gen1 di tipo C (supporta protezione da scariche elettrostatiche)
- 2 x porte USB 3.1 Gen1 (supporta protezione da scariche elettrostatiche)
- 1 x porta LAN RJ-45 con LED (ACT/LINK LED e SPEED LED)
- Connettori audio HD: altoparlante posteriore/centrale/basso/ingresso linea/altoparlante anteriore/microfono

Archiviazione

- 4 x connettori SATA3 6,0 Gb/s, supporto RAID (RAID 0, RAID 1, e RAID 10), NCQ, AHCI e Hot Plug
- 1 x socket Ultra M.2, supporta il modulo M.2 SATA3 6,0 Gb/s di tipo M Key 2280 ed il modulo M.2 PCI Express fino a Gen3 x4 (32 Gb/s) (con Ryzen CPU) o Gen3 x2 (16 Gb/s) (con APU serie A)*

* Supporto di SSD NVMe come disco d'avvio

Connettore

- 1 x connettore LPC
- 1 x Collettore LED AMD FAN
- * Il collettore LED ventola AMD supporta strisce LED con un carico massimo di 3A (36W) e di lunghezza massima di 2,5 m.
- 1 x connettore ventola CPU (4-pin)
- * Il connettore ventola CPU supporta ventole CPU con potenza massima di 1 A (12 W).
- 1 x Connettore ventola telaio (4-pin)
- 1 x connettore ventola telaio/ventola pompa dell'acqua (4 pin) (Smart Fan Speed Control)
- * La ventola telaio/ventola pompa dell'acqua supporta ventole di sistemi di raffreddamento ad acqua di potenza massima di 1,5A (18W).
- 1 x connettore alimentazione ATX 24 pin
- 1 x connettore alimentazione 12V 8-pin (connettore alimentazione ad alta densità)
- 1 x connettore audio pannello frontale
- 1 x collettore USB AMD LED FAN

- 1 x connettore USB 2.0 (supporto di 2 porte USB 2.0) (supporta protezione da scariche elettrostatiche)
- 1 x connettore USB 3.1 Gen1 (supporto di 2 porte USB 3.1 Gen1) (supporta protezione da scariche elettrostatiche)

SO

- Microsoft® Windows® 10 64 bit

Especificaciones

- Plataforma**
- Factor de forma Mini-ITX
 - Circuito impreso (PCB) de 2 oz de cobre

- CPU**
- Admite APU de la serie A AM4 con zócalo AMD (Bristol Ridge) y CPU de la serie Ryzen (Summit Ridge, Raven Ridge y Pinnacle Ridge)
 - Digi Power design
 - Diseño de 8 fases de alimentación
 - Admite refrigeración por agua de 105 W (Pinnacle Ridge); admite refrigeración por agua de 95 W (Summit Ridge); admite refrigeración por agua de 65 W (Raven Ridge)

- Conjunto de chips**
- AMD Promontory A320

- Memoria**
- Tecnología de memoria DDR4 de doble canal
 - 2 x ranuras DIMM DDR4
 - Las CPU de la serie AMD (Pinnacle Ridge) admiten memoria sin búfer ECC y no ECC DDR4 3466+(OC)/3200(OC)/2933/2667/2400/2133*
 - Las CPU de la serie AMD (Summit Ridge) admiten memoria sin búfer ECC y no ECC DDR4 3466+(OC)/3200(OC)/2933(OC)/2667/2400/2133*
 - Las CPU de la serie AMD (Raven Ridge) admiten memoria sin búfer no ECC DDR4 3466+(OC)/3200(OC)/2933(OC)/2667/2400/2133*
 - APU de la serie Gen A de la 7ª generación AMD admiten memoria sin bufer DDR4 2400/2133 ECC y no ECC*
- * Para CPU de la serie Ryzen (Raven Ridge), ECC solamente se admite con CPU PRO.
- * Para obtener más información, consulte la lista de memorias compatibles en el sitio web de ASRock. (<http://www.asrock.com/>)
- Capacidad máxima de memoria del sistema: 32 GB
 - Contacto 15µ Gold en ranuras DIMM

- Ranura de expansión**
- CPU de la serie AMD Ryzen (Summit Ridge y Pinnacle Ridge)**
- 1 x ranura PCI Express 3.0 x16 (PCIe1:modo x16)*
- APU de la serie A AMD 7ª (Raven Ridge)**
- 1 x ranura PCI Express 3.0 x16 (PCIe1:modo x8)*
- * Admite unidad de estado sólido de NVMe como disco de arranque

Gráficos

- Tarjeta gráfica de la serie AMD Radeon™ Vega integrada en APU de la serie Ryzen*
- Gráficos de la serie R de AMD Radeon™ integrados en APU de las series A*

* El soporte real puede variar según la CPU

- DirectX 12, Pixel Shader 5.0
- Memoria máxima compartida de 2GB
- Admite 2 HDMI con una resolución máxima de 4K x 2K (4096x2160) a 24 Hz / (3840x2160) a 30 Hz
- Admite Sincronización automática entre audio y vídeo, color profundo (12 bpc), xvYCC y HBR (audio de alta tasa de bits) con puertos HDMI (se necesita un monitor compatible con HDMI)
- Admite HDCP con puertos HDMI
- Compatible con reproducción Blu-ray (BD) Full HD de 1080p con puertos HDMI

Audio

- 7.1 Audio CH HD con Protección de contenido (Realtek ALC1220 Audio Codec)
- Compatible con audio Blu-ray Premium
- Admite protección contra sobretensiones
- Tapas de audio Nichion de la serie Fine Gold
- DAC con SNR de 120 dB con amplificador diferencial
- Entrada de alimentación pura
- Tecnología de unidad directa
- Protección de aislamiento de PCB
- Detección de impedancia en el puerto salida de línea
- Capas PCB individuales para canal de audio D/I

LAN

- Gigabit LAN 10/100/1000 Mb/s
- GigaLAN Intel® I211AT
- Admite la función Reactivación de LAN
- Admite protección contra rayos y descargas electrostáticas (ESD)
- Admite Ethernet 802.3az de eficiencia energética
- Admite PXE

E/S en panel posterior

- 1 x Puerto de ratón/teclado PS/2
- 2 x Puertos HDMI
- 1 x puerto de salida SPDIF óptica
- 2 x puertos USB 2.0 (admite protección contra descargas electrostáticas)
- 1 x Puerto USB 3.1 Gen1 de tipo A (admite protección contra descargas electrostáticas)
- 1 x Puerto USB 3.1 Gen1 de tipo C (admite protección contra descargas electrostáticas)

- 2 x Puertos USB 3.1 Gen1 (admite protección contra descargas electrostáticas)
- 1 x Puerto LAN RJ-45 con LED (LED DE ACTIVIDAD/ENLACE y LED DE VELOCIDAD)
- Conector de audio HD: Altavoz trasero / Central / Graves / Entrada de línea / Altavoz frontal / Micrófono

Almacenamiento

- 4 x conectores SATA3 de 6,0 Gb/s, compatible con RAID (RAID 0, RAID 1 y RAID 10), NCQ, AHCI y conexión en caliente
- 1 x Zócalo Ultra M.2 que admite el módulo SATA3 6,0 Gb/s M.2 de tipo 2280 con clave M y el módulo PCI Express M.2 hasta Gen3 x4 (32 Gb/s) (con CPU de la serie Ryzen) o Gen3 x2 (16 Gb/s) (con APU de la serie A)*

* Admite unidad de estado sólido de NVMe como disco de arranque

Conector

- 1 x Conector LPC
- 1 x Base de conexiones de LED de ventilador AMD

* La base de conexiones de LED del ventilador AMD admite bandas de LED con una carga máxima de 3 A (36 W) y una longitud de hasta 2,5 m.

- 1 x Conector para ventilador de la CPU (4 pines)

* El conector para ventilador de la CPU admite ventilador de la CPU con una potencia de ventilador de 1 A (12 W) máxima.

- 1 x Conector para ventilador del chasis (4 contactos)
- 1 x Conector (4 contactos) para el ventilador de la bomba de agua/del chasis (control de velocidad de ventilador inteligente)

* El ventilador de la bomba de agua/del chasis admite ventilador del disipador por agua con una potencia de ventilador máxima de 1,5 A (18 W).

- 1 x conector de alimentación ATX de 24 contactos
- 1 x conector de alimentación de 8 pines y 12V (conector de alimentación de alta densidad)
- 1 x Conector de audio en el panel frontal
- 1 x Base de conexiones USB de ventilador de LED AMD
- 1 x base de conexiones USB 2.0 (admite 2 puertos USB 2.0). Admite protección contra descargas electrostáticas.
- 1 x base de conexiones USB 3.1 Gen1 (admite 2 puertos USB 3.1 Gen1). Admite protección contra descargas electrostáticas.

SO

- Microsoft® Windows® 10 64 bits

Технические характеристики

Платформа

- Форм-фактор Mini-ITX
- Медная печатная плата 2 унции

ЦП

- Поддерживаются процессоры AMD APU серии A (Bristol Ridge) и ЦП серии Ryzen (Summit Ridge, Raven Ridge и Pinnacle Ridge) под сокет AM4
- Digi Power design
- Система питания 8
- Поддерживается водяное охлаждение, 105 Вт (Pinnacle Ridge); Поддерживается водяное охлаждение, 95 Вт (Summit Ridge); Поддерживается водяное охлаждение, 65 Вт (Raven Ridge)

Чипсет

- AMD Promontory A320

Память

- Двухканальная память DDR4
 - 2 х гнезда DDR4 DIMM
 - Процессоры AMD серии Ryzen (Pinnacle Ridge) поддерживают модули памяти DDR4 3466+(OC)/3200(OC)/2933/2667/2400/2133, ECC, non-ECC и Unbuffered*
 - Процессоры AMD серии Ryzen (Summit Ridge) поддерживают модули памяти DDR4 3466+(OC)/3200(OC)/2933(OC)/2667/2400/2133, ECC, non-ECC и Unbuffered*
 - Процессоры AMD серии Ryzen (Raven Ridge) поддерживают модули памяти DDR4 3466+(OC)/3200(OC)/2933(OC)/2667/2400/2133, non-ECC и Unbuffered*
 - Для процессоров AMD APU серии A 7-го поколения поддерживаются модули небуферизованной памяти DDR4 2400/2133 с ECC и без ECC*
- * Для процессоров серии Ryzen (Raven Ridge) модуль памяти ECC поддерживается только процессорами PRO.
- * Дополнительная информация представлена в Списке совместимой памяти (Memory Support List) на веб-сайте ASRock. (<http://www.asrock.com/>)
- Максимальный объем ОЗУ: 32 ГБ
 - Гнезда DIMM с золочеными контактами 15мк

Слот расширения

Процессоры AMD серии Ryzen (Summit Ridge и Pinnacle Ridge)

- 1 x Слот PCI Express 3.0 x16 (PCIЕ1:режим x16)*

Процессоры AMD APU серии A 7-го поколения / Raven Ridge

- 1 x Слот PCI Express 3.0 x16 (PCIЕ1:режим x8)*

* Поддерживаются в качестве загрузочных SSD-диски типа NVMe.

Графическая подсистема

- Встроенный видеоадаптер AMD Radeon™ серии Vega в процессорах APU серии Ryzen*
- Встроенный видеоадаптер AMD Radeon™ R в процессорах APU серий A*

* Фактическая поддержка зависит от ЦП

- DirectX 12, пиксельные шейдеры 5.0
- Максимальный объем общей памяти: 2 ГБ
- Поддерживаются 2 порта HDMI с максимальным разрешением до 4К x 2К (4096x2160) при частоте обновления 24 Гц (3840x2160 при 30 Гц)
- Поддерживаются Auto Lip Sync, Deep Color (12 бит/цвет), xvYCC и HBR (High Bit Rate Audio) через порты HDMI (требуется соответствующий HDMI-монитор)
- Поддерживается HDCP через порты HDMI.
- Поддержка воспроизведения Full HD 1080p Blu-ray (BD) через порты HDMI

Звук

- 7.1-канальный звук высокой четкости HD Audio с защитой данных (аудиокодек Realtek ALC1220)
- Поддержка Premium Blu-ray Audio
- Защита от перепадов напряжения в электрической сети
- Конденсаторы для аудиосистем серии Nichicon Fine Gold
- ЦАП с отношением сигнал/шум 120 дБ с дифференциальным усилителем
- Стабилизированный вход питания
- Технология Direct Drive
- Изолирующее экранирование печатной платы
- Определение сопротивления нагрузки, подключенной к линейному выходу.
- Отдельные слои печатной платы для левого и правого аудиоканалов

LAN

- Gigabit Ethernet 10/100/1000 Мбит/с
- GigaLAN Intel® I211AT
- Поддерживается пробуждение по ЛВС
- Молниезащита и защита от электростатических разрядов
- Поддерживается Energy Efficient Ethernet 802.3az
- Поддерживается PXE

Порты ввода-вывода на задней панели

- 1 х порт PS/2 для мыши/клавиатуры
- 2 х порта HDMI
- 1 х оптический выходной SPDIF
- 2 х порта USB 2.0 (с защитой от электростатических разрядов)
- 1 х Порт USB 3.1 Gen1 тип A (с защитой от электростатических разрядов)
- 1 х Порт USB 3.1 Gen1 тип C (с защитой от электростатических разрядов)
- 2 х порта USB 3.1 Gen1 (с защитой от электростатических разрядов)
- 1 х порт ЛВС RJ-45 с индикаторами («Активность/Соединение» и «Скорость»)
- Разъемы HD Audio: тыловые AC / центральная AC / сабвуфер / линейный вход / фронтальные AC / микрофон

Запоминающие устройства

- 4 х порта SATA3 со скоростью передачи данных 6,0 Гб/с, поддержка RAID (RAID 0, RAID 1 и RAID 10), NCQ, AHCI и «горячего подключения».
- 1 х слот Ultra M.2, поддерживается модуль M.2 SATA3 с ключом М типа 2280 с пропускной способностью 6,0 Гб/с и модуль M.2 PCI Express до версии Gen3 x4 (32 Гб/с) (с процессором Ryzen) или Gen3 x2 (16 Гб/с) (с процессора APU серии A)*

* Поддерживаются в качестве загрузочных SSD-диски типа NVMe.

Разъемы

- 1 x колодка LPC
- 1 x колодка для подключения светодиодной подсветки вентилятора AMD.
- * Колодка для подключения светодиодной подсветки вентилятора AMD поддерживает светодиодные ленты мощностью не более 36 Ватт (3 А) и длиной до 2,5 м.
- 1 x разъем для вентилятора охлаждения ЦП, 4-контактный
- * Разъем процессорного вентилятора поддерживает вентилятор с потребляемым током не более 1 А (12 Вт).
- 1 x разъем для корпусного вентилятора (4-контактный)
- 1 x разъем для корпусного вентилятора или водяной помпы (4-контактный) (смарт-регулятор скорости вентилятора)
- * Разъем для корпусного вентилятора или водяной помпы поддерживает вентилятор с потребляемым током не более 1,5 А (18 Вт).
- 1 x разъем питания ATX, 24-контактный
- 1 x разъем питания 12 В (8-контактный разъем питания высокой плотности)
- 1 x аудиоразъем на передней панели
- 1 x колодка для подключения USB-кулера AMD со светодиодной подсветкой
- 1 x колодка USB 2.0 (2 порта USB 2.0 с защитой от электростатических разрядов)
- 1 x колодка USB 3.1 Gen1 (2 порта USB 3.1 Gen1 с защитой от электростатических разрядов)

Операционные системы

- Microsoft® Windows® 10 (64-разрядная)

Especificações

- Plataforma**
- Formato Mini-ITX
 - PCB 2oz de Cobre

- CPU**
- Suporta soquete AMD série-A AM4 APUs (Bristol Ridge) e CPUs série Ryzen (Summit Ridge, Raven Ridge e Pinnacle Ridge)
 - Digi Power design
 - Design com 8 fases de alimentação
 - Suporta 105W Water Cooling (Pinnacle Ridge); Suporta 95W Water Cooling (Summit Ridge); Suporta 65W Water Cooling (Raven Ridge)

- Chipset**
- AMD Promontory A320

- Memória**
- Tecnologia de memória DDR4 de dois canais
 - 2 x Slots DIMM DDR4
 - CPUs série AMD (Pinnacle Ridge) suporta DDR4 3466+(OC)/3200(OC)/2933/2667/2400/2133 ECC & não-ECC, memória un-buffered*
 - CPUs série AMD Ryzen (Summit Ridge) suporta DDR4 3466+(OC)/3200(OC)/2933(OC)/2667/2400/2133 ECC & não-ECC, memória un-buffered*
 - CPUs série AMD Ryzen (Raven Ridge) suporta DDR4 3466+(OC)/3200(OC)/2933(OC)/2667/2400/2133 não-ECC, memória un-buffered*
 - APUs AMD 7^ª Ger Série A suportam DDR4 2400/2133 ECC e não ECC, sem memória intermediária*
- * Para CPUs série Ryzen (Raven Ridge), ECC só é suportado com CPUs PRO.
- * Por favor, consulte a Lista de Suporte de Memória no site da ASRock para obter mais informação. (<http://www.asrock.com/>)
- Capacidade máxima da memória do sistema: 32GB
 - Contato em Ouro 15µ nos slots DIMM

- Slot de expansão**
- CPUs AMD séries Ryzen (Summit Ridge e Pinnacle Ridge)**
- 1 x Slot PCI Express 3.0 x16 (PCIE1:modo x16)*
- APUs AMD 7^ª Série A / Raven Ridge**
- 1 x Slot PCI Express 3.0 x16 (PCIE1:x8 modo)*
- * Suporta NVMe SSD nos discos de inicialização

Gráficos

- AMD Radeon™ Integrado Série Vega Gráficas na Série Ryzen APU*
 - AMD Radeon™ Integrado Série R Gráfica em Séries A APU*
- * Suporte atual pode variar por CPU
- DirectX 12, Pixel Shader 5.0
 - Memória compartilhada máxima de 2GB
 - Suporta 2 x HDMI com resolução máx. até 4K x 2K (4096x2160) @ 24Hz / (3840x2160) @ 30Hz
 - Suporta Auto sincronização labial, Deep Color (12bpc), xvYCC e HBR (High Bit Rate Audio) com portas HDMI (É necessário um monitor compatível com HDMI)
 - Suporta HDCP com Portas HDMI
 - Suporta reprodução Full HD 1080p Blu-ray (BD) com Portas HDMI

Áudio

- Áudio HD de 7.1 canais com proteção de conteúdo (Codec de áudio Realtek ALC1220)
- Suporte áudio Blu-ray superior
- Suporta Proteção de Sobretenção
- Capacitor de Áudio Série Ouro Fino Nichicon
- 120dB SNR DAC com amplificador diferencial
- Ligação Pura
- Tecnologia de drive direto
- Blindagem de isolamento PCB
- Sensoriamento de Impedância na porta de Saída de Linha
- Camadas de PCB individuais por canal de áudio R/L

LAN

- LAN Gigabit a 10/100/1000 Mb/s
- GigaLAN Intel® I211AT
- Suporta Wake-On-LAN
- Oferece Suporte à Proteção de Relâmpago/ESD
- Suporta Energy Efficient Ethernet 802.3az
- Suporta PXE

E/S do painel posterior

- 1 x Porta PS/2 para mouse/teclado
- 2 x Portas HDMI
- 1 x Porta de saída SPDIF ótica
- 2 x Portas USB 2.0 (Suporta Proteção ESD)

- 1 x Porta USB 3.1 Gen1 Tipo A (Suporta Proteção ESD)
- 1 x Porta USB 3.1 Gen1 Tipo C (Suporta Proteção ESD)
- 2 x Portas USB 3.1 Gen1 (Suporta Proteção ESD)
- 1 x Porta LAN RJ-45 com LED (LED ACT/LINK e LED DE VELOCIDADE)
- Fichas de áudio HD: Alto-falante posterior / Central / Graves / Entrada de linha / Alto-falante frontal / Microfone

Armazenamento

- 4 x Conectores SATA3 6,0 Gb/s, suporta RAID (RAID 0, RAID 1, e RAID 10), NCQ, AHCI e Conexão a Quente
- 1 x soquete M.2 Ultra, suporta Chave M tipo 2280 módulo M.2 SATA3 6,0 Gb/s e módulo M.2 PCI Express até Gen3 x4 (32 Gb/s) (com CPU Série Ridge) ou Gen3 x2 (16 Gb/s) (com APU Série-A)*

* Suporta NVMe SSD nos discos de inicialização

Conector

- 1 x Plataforma LPC
- 1 x Cabeçote de LED Fan AMD

* O suporte de LED do ventilador AMD suporta tiras de LED de carga máxima de 3A (36W) e comprimento até 2,5M.

- 1 x Conector da ventoinha da CPU (4 pinos)

* O Conector do Ventilador de CPU suporta o ventilador de CPU de alimentação máxima 1A do ventilador (12W).

- 1 x Conector da ventoinha do Gabinete (4 pinos)
- 1 x Conector de Ventilador de Chassi/Ventilador da Bomba de Água (4 pinos) (Controle de Velocidade de Ventoinha Inteligente)

* O Ventilador de Chassi/Ventilador da Bomba de Água suporta o ventilador de refrigerador a água de 1,5A máximo (18W) potência do ventilador.

- 1 x Conector alimentação ATX 24 pinos
- 1 x Conector de energia 8-pinos 12V (Conector de energia de alta densidade)
- 1 x Conector de áudio do painel frontal
- 1 x Plataforma AMD LED Fan USB
- 1 x Plataforma USB 2.0 (Suporta 2 portas USB 2.0) (Suporta Proteção ESD)
- 1 x Plataforma USB 3.1 Gen1 (Suporta 2 portas USB 3.1 Gen1) (Suporta Proteção ESD)

SO

- Microsoft® Windows® 10 64-bit

Specyfikacje

Platforma

- Współczynnik kształtu Mini-ITX
- PCB z 2 uncjami miedzi

CPU

- Obsługa CPU serii AMD AM4 Socket APU serii A (Bristol Ridge) z Ryzen (Summit Ridge, Raven Ridge oraz Pinnacle Ridge)
- Digi Power design
- Sekcja zasilania 8 Power Phase Design
- Obsługa chłodzenia wodnego 105W (Pinnacle Ridge);
Obsługa chłodzenia wodnego 95W (Summit Ridge);
Obsługa chłodzenia wodnego 65W (Raven Ridge)

Chipset

- AMD Promontory A320

Pamięć

- Technologia pamięci Dual Channel DDR4
- 2 x gniazda DDR4 DIMM
- Seria CPU AMD Ryzen (Pinnacle Ridge) z obsługą DDR4 3466+(OC)/3200(OC)/2933/2667/2400/2133 ECC i nie-ECC, pamięć niebuforowana*
- Seria CPU AMD Ryzen (Summit Ridge) z obsługą DDR4 3466+(OC)/3200(OC)/2933(OC)/2667/2400/2133 ECC i nie-ECC, pamięć niebuforowana*
- Seria CPU AMD Ryzen (Raven Ridge) z obsługą DDR4 3466+(OC)/3200(OC)/2933(OC)/2667/2400/2133 nie-ECC, pamięć niebuforowana*
- Seria CPU AMD 7th Gen APU serii A z obsługą DDR4 2400/2133 ECC i nie-ECC, pamięć niebuforowana*

* Dla serii CPU Ryzen (Raven Ridge), ECC jest obsługiwana tylko z CPU PRO.

* Sprawdź listę obsługiwanej pamięci na stronie internetowej ASRock w celu uzyskania dalszych informacji.

(<http://www.asrock.com/>)

- Maks. wielkość pamięci systemowej: 32GB
- 15μm połączone styki w gniazdach DIMM

Gniazdo rozszerzenia

AM4 Ryzen (Summit Ridge oraz Pinnacle Ridge)

- 1 x gniazda PCI Express 3.0 x16 (w x16 (PCIE1))*

AM4 7th APU serii A / Raven Ridge

- 1 x gniazda PCI Express 3.0 x16 (w x8 (PCIE1))*

* Obsługa SSD NVMe, jako dysków rozruchowych

Grafika

- Zintegrowana karta graficzna AMD Radeon™ serii Vega w APU serii Ryzen*
 - Zintegrowana karta graficzna AMD Radeon™ serii R w APU serii A*
- * Rzeczywista obsługa zależy od CPU
- DirectX 12, Pixel Shader 5.0
 - Maks. współdzielona pamięć 2GB
 - Obsługa HDMI z maks. rozdzielczością do 4K x 2K (4096x2160) przy 24Hz / (3840x2160) przy 30Hz
 - Obsługa Auto Lip Sync, Deep Color (12bpc), xvYCC i HBR (High Bit Rate Audio) z portami HDMI (Wymagany monitor zgodny z HDMI)
 - Obsługa HDCP z portem HDMI
 - Obsługa odtwarzania Blu-ray (BD) Full HD 1080p z portem HDMI

Audio

- Audio HD 7.1 CH z zabezpieczeniem treści (Kodek audio Realtek ALC1220)
- Obsługa audio Blu-ray Premium
- Obsługa zabezpieczenia przed przepięciami
- Nichicon Fine Gold Series Audio Caps
- 120dB SNR DAC ze wzmacniaczem różnicowym
- Pure Power-In
- Technologia Direct Drive
- Ekranowanie izolacji PCB
- Wykrywanie impedancji na porcie wyjścia liniowego
- Indywidualne warstwy PCB dla kanału audio R/L

LAN

- Gigabit LAN 10/100/1000 Mb/s
- GigaLAN Intel® I211AT
- Obsługa Wake-On-LAN
- Obsługa zabezpieczenia przed wyładowaniami atmosferycznymi/ESD
- Obsługa Energy Efficient Ethernet 802.3az
- Obsługa PXE

**Tylny panel
Wejścia/Wyjścia**

- 1 x port myszy/klawiatury PS/2
- 2 x porty HDMI
- 1 x port optycznego wyjścia SPDIF
- 2 x porty USB 2.0 (Obsługa zabezpieczenia ESD)
- 1 x port USB 3.1 Gen1 typu A (Obsługa zabezpieczenia ESD)

- 1 x port USB 3.1 Gen1 typu C (Obsługa zabezpieczenia ESD)
- 2 x porty USB 3.1 Gen1 (Obsługa zabezpieczenia ESD)
- 1 x porty LAN RJ-45 z LED (LED ACT/LINK i LED SPEED)
- Gniazda audio HD: Głośnik tylny / Centralny / Basy / Wejście liniowe / Głośnik przedni / Mikrofon

Przechowywanie

- 4 x złącza SATA3 6,0 Gb/s, obsługa RAID (RAID 0, RAID 1 i RAID 10), NCQ, AHCI i Hot Plug
- 1 x gniazdo Ultra M.2 (M2_1), obsługa Key M typu 2280 modułu M.2 SATA3 6,0 Gb/s i modułu M.2 PCI Express do Gen3 x4 (32 Gb/s) (CPU serii Ryzen) lub Gen3 x2 (16 Gb/s) (APU serii A)*

* Obsługa SSD NVMe, jako dysków rozruchowych

Złącze

- 1 x złącze główkowe LPC
- 1 x złącze główkowe LED wentylatora AMD
- * Złącze główkowe LED wentylatora AMD obsługuje paski LED o maksymalnym obciążeniu 3A (36W) i długości do 2,5 m.
- 1 x złącze wentylatora CPU (4-pinowe)
- * Złącze wentylatora CPU obsługuje wentylator CPU maksymalnym prądem zasilania wentylatora 1A (12W).
- 1 x złącze wentylatora obudowy (4-pinowe)
- 1 x złącze wentylatora obudowy/pompy wodnej (4-pinowe) (Inteligentne sterowanie prędkością obrotową wentylatora)
- * Złącze wentylatora obudowy/pompy wodnej obsługuje wentylator układu chłodzenia maksymalnym prądem zasilania wentylatora 1.5A (18W).
- 1 x 24 pinowe złącze zasilania ATX
- 1 x 8 pinowe 12V złącze zasilania (Złącze zasilania Hi-Density)
- 1 x złącze audio na panelu przednim
- 1 x złącze główkowe wentylatora LED AMD
- 1 x złącze główkowe USB 2.0 (Obsługa 2 portów USB 2.0) (Obsługa zabezpieczenia ESD)
- 1 x port główkowe USB 3.1 Gen1 (Obsługa 2 portów USB 3.1 Gen1) (Obsługa zabezpieczenia ESD)

System operacyjny

- Microsoft® Windows® 10 64-bitowy

규격

플랫폼

- Mini-ITX 폼 팩터
- 2 온스 구리 PCB

CPU

- AMD Socket AM4 A 시리즈 APU(Bristol Ridge) 및 Ryzen 시리즈 CPU(Summit Ridge, Raven Ridge 및 Pinnacle Ridge) 지원
- Digi Power design
- 8 개 전원 위상 구조
- 105W 워터 쿨링 (Pinnacle Ridge) 지원 , 95W 워터 쿨링 (Summit Ridge) 지원 , 65W 워터 쿨링 (Raven Ridge) 지원

칩세트

- AMD Promontory A320

메모리

- 듀얼 채널 DDR4 메모리 기술
 - DDR4 DIMM 슬롯 2 개
 - AMD Ryzen 시리즈 CPU(Pinnacle Ridge) 는 DDR4 3466+(OC)/3200(OC)/2933/2667/2400/2133 ECC 및 비 ECC, 비버퍼링 메모리를 지원합니다.*
 - AMD Ryzen 시리즈 CPU(Summit Ridge) 는 DDR4 3466+(OC)/3200(OC)/2933(OC)/2667/2400/2133 ECC 및 비 ECC, 비버퍼링 메모리를 지원합니다.*
 - AMD Ryzen 시리즈 CPU(Raven Ridge) 는 DDR4 3466+(OC)/3200(OC)/2933(OC)/2667/2400/2133 비 ECC, 비버퍼링 메모리를 지원합니다.*
 - AMD 7 세대 A- 시리즈 APU 는 DDR4 2400/2133 ECC 및 비 ECC, 비버퍼링 메모리를 지원합니다.*
- * Ryzen Series CPU(Raven Ridge) 의 경우 , ECC 는 PRO CPU 에서만 지원합니다 .
- * 추가 정보를 원하시면 ASRock 웹사이트에 있는 메모리 지원 목록을 참조하십시오 . (<http://www.asrock.com/>)
- 시스템 메모리 최대 용량 : 32GB
 - DIMM 슬롯에 15 Gold Contact 장착

확장 슬롯

AMD Ryzen 시리즈 CPU (Summit Ridge 및 Pinnacle Ridge)

- PCI Express 3.0 x16 슬롯 1 개 (PCIe1:x16 모드)*

AMD 7 세대 A- 시리즈 APU / Raven Ridge

- PCI Express 3.0 x16 슬롯 1 개 (PCIe1:x8 모드)*

* NVMe SSD 를 부팅 디스크로 사용 가능하도록 지원

그래픽

- Ryzen Series APU 의 통합형 AMD Radeon™ Vega Series 그래픽 *
- A- 시리즈 APU 의 경우 통합된 AMD Radeon™ R 시리즈 그래픽 *

* 실제 지원은 CPU 에 따라 다를 수 있음

- DirectX 12, Pixel Shader 5.0
- 최대 공유 메모리 2GB
- 2 개의 HDMI 지원 (최대 해상도 4K x 2K (4096x2160) @ 24Hz / (3840x2160) @ 30Hz)
- Auto Lip Sync, Deep Color (12bpc), xvYCC 및 HBR (High Bit Rate Audio)(HDMI 포트 포함) 지원 (HDMI 호환 모니터 필요)
- HDMI 포트를 이용한 HDCP 지원
- HDMI 포트를 이용한 Full HD 1080p 블루레이 (BD) 재생 지원

오디오

- 콘텐츠 보호를 이용한 7.1 CH HD 오디오 지원 (Realtek ALC1220 오디오 코덱)
- 프리미엄 Blu-ray 오디오 지원
- 서비 보호 지원
- Nichicon Fine Gold 시리즈 오디오 캡
- 디퍼렌셜 증폭기 포함 120dB SNR DAC
- 순수 전원 입력
- 다이렉트 드라이브 기술
- PCB 절연 차폐
- 라인 출력 포트의 임피던스 감지
- R/L 오디오 채널용 개별 PCB 레이어

LAN

- Gigabit LAN 10/100/1000 Mb/s
- GigaLAN Intel® I211AT
- Wake-On-LAN 지원
- 번개 /ESD 보호 지원
- 절전형 이더넷 802.3az 지원
- PXE 지원

후면 패널 I/O

- PS/2 마우스 / 키보드 포트 1 개
- HDMI 포트 2 개
- 광학 SPDIF 출력 포트 1 개

- USB 2.0 포트 2 개 (ESD 보호 지원)
- USB 3.1 Gen1 타입 A 포트 1 개 (ESD 보호 지원)
- USB 3.1 Gen1 타입 C 포트 1 개 (ESD 보호 지원)
- USB 3.1 Gen1 포트 2 개 (ESD 보호 지원)
- LED 장착 RJ-45 LAN 포트 1 개 (ACT/LINK LED 및 SPEED LED)
- HD 오디오 잭 : 후면 스피커 / 중앙 / 베이스 / 라인 입력 / 전면 스피커 / 마이크

저장 장치

- SATA3 6.0 Gb/s 커넥터 4 개가 RAID(RAID 0, RAID 1 및 RAID 10), NCQ, AHCI 및 핫 플러그를 지원합니다 .
- Ultra M.2 소켓 1 개 , M 키 타입 2280 M.2 SATA3 6.0 Gb/s 모듈 지원 및 Gen3까지의 M.2 PCI Express 모듈 4 개 지원 (32 Gb/s) 까지 또는 Gen3(A 시리즈 APU 탑재)의 경우 2 개 (16 Gb/s) 까지 지원 *
- * NVMe SSD 를 부팅 디스크로 사용 가능하도록 지원

커넥터

- LPC 헤더 1 개
- AMD 팬 LED 헤더 1 개
- * AMD 팬 LED 헤더는 최대 부하 3A(36W) 및 최대 길이 2.5M의 LED 스트립을 지원합니다 .
- CPU 팬 커넥터 (4 핀) 1 개
- * CPU 팬 커넥터는 팬 전력이 최대 1A(12W) 인 CPU 팬을 지원합니다 .
- 새시 팬 커넥터 (4 핀) 1 개
- 새시 / 워터 펌프 팬 커넥터 (4 핀) 1 개 (스마트 팬 속도 제어)
- * 새시 / 워터 펌프 팬은 팬 전력이 최대 1.5A(18W) 인 수냉식 쿨러 팬을 지원합니다 .
- 24 핀 ATX 전원 커넥터 1 개
- 8 핀 12V 전원 커넥터 1 개 (고밀도 전원 커넥터)
- 전면 패널 오디오 커넥터 1 개
- AMD LED 팬 USB 헤더 1 개
- USB 2.0 헤더 1 개 (USB 2.0 포트 2 개 지원) (ESD 보호 지원)
- USB 3.1 Gen1 헤더 1 개 (USB 3.1 Gen1 포트 2 개 지원) (ESD 보호 지원)

OS

- Microsoft® Windows® 10 64- 비트

仕様

- プラットフォーム**
- ミニ ITX フォームファクター
 - 2 オンスのコパー製 PCB

- CPU**
- AMD ソケット AM4 A シリーズ APU (Bristol Ridge) および Ryzen シリーズ CPU (Summit Ridge、Raven Ridge および Pinnacle Ridge) に対応
 - Digi Power design
 - 8 電源フェーズ設計
 - 105W 水冷 (Pinnacle Ridge) に対応。95W 水冷 (Summit Ridge) に対応。65W 水冷 (Raven Ridge) に対応

- チップセット**
- AMD Promontory A320

- メモリ**
- デュアルチャンネル DDR4 メモリ機能
 - 2 x DDR4 DIMM スロット
 - AMD Ryzen シリーズ CPU (Pinnacle Ridge) は、DDR4 3466+ (OC) / 3200 (OC) / 2933 / 2667 / 2400 / 2133 ECC および非 ECC、アンバッファードメモリに対応します *
 - AMD Ryzen シリーズ CPU (Summit Ridge) は、DDR4 3466+ (OC) / 3200 (OC) / 2933 / 2667 / 2400 / 2133 ECC および非 ECC、アンバッファードメモリに対応します *
 - AMD Ryzen シリーズ CPU (Raven Ridge) は、DDR4 3466+ (OC) / 3200 (OC) / 2933 / 2667 / 2400 / 2133 非 ECC、アンバッファードメモリに対応します *
 - AMD 第 7 世代 A シリーズ APU は DDR4 2400 / 2133 ECC、および、ノン ECC、アンバッファードメモリに対応します。*
- * Ryzen シリーズ CPU (Raven Ridge) の場合、ECC は PRO CPU のみに対応します。
- * 詳細については、ASRock ウェブサイトのメモリーサポート一覧を参照してください。(http://www.asrock.com/)
- システムメモリの最大容量: 32GB
 - DIMM スロットに 15 μ ゴールドコンタクトを採用

- 拡張スロット**
- AMD Ryzen シリーズ CPU (Summit Ridge および Pinnacle Ridge)

- 1 x PCI Express 3.0 x16 スロット (PCI E1 : x16 モード)*

AMD 第 7 世代 A シリーズ APU / Raven Ridge

- 1 x PCI Express 3.0 x16 スロット (PCI E1 : x8 モード)*

* 起動ディスクとして NVMe SSD に対応

グラフィックス

- AMD Radeon™ Vega シリーズグラフィックスを Ryzen シリーズ APU に統合 *
- 統合された AMD Radeon™ R シリーズグラフィックス (A シリーズ APU)*
- * 実際のサポートは CPU によって異なることがあります
 - DirectX 12、Pixel Shader 5.0
 - 最大共有メモリ 2GB
 - 最大解像度 4K x 2K (4096x2160) @ 24Hz / (3840x2160) @ 30Hz までの 2 x HDMI に対応
 - HDMI ポートでオートルリップシンク、ディープカラー (12bpc)、xvYCC、および、HBR (高ビットレートオーディオ) に対応 (HDMI 対応モニターが必要です)
 - HDMI ポートで HDCP に対応
 - HDMI ポートで Full HD 1080p Blu-ray (BD) 再生に対応

オーディオ

- 7.1 CH HD オーディオ、コンテンツプロテクション付き(Realtek ALC1220 オーディオコーデック)
- プレミアム・ブルーレイ・オーディオ・サポート
- サージ保護に対応
- ニチコン製ファインゴールドシリーズオーディオコンデンサ
- SNR 比 120dB の DAC (差動アンプ搭載)
- Pure Power-In (ピュアパワーイン)
- ダイレクトドライブテクノロジー
- PCB 絶縁シールド
- ライン出力ポートにインピーダンスセンシング装備
- R/L オーディオチャンネル用個別 PCB レイヤ

LAN

- ギガビット LAN 10/100/1000 Mb/s
- GigaLAN Intel® I211AT
- Wake-On-LAN (ウェイク オン ラン) に対応
- 雷 / 静電気放電 (ESD) 保護に対応
- エネルギー効率のよいイーサネット 802.3az をサポート
- PXE をサポート

リアパネル I/O

- 1 x PS/2 マウス / キーボードポート
- 2 x HDMI ポート
- 1 x 光 SPDIF 出力ポート
- 2 x USB 2.0 ポート (静電気放電 (ESD) 保護に対応)
- 1 x USB 3.1 Gen1 Type-A ポート (静電気放電 (ESD) 保護に対応)

- 1 x USB 3.1 Gen1 Type-C ポート(静電気放電(ESD)保護に対応)
- 2 x USB 3.1 Gen1 ポート(静電気放電(ESD)保護に対応)
- LED 付き 1 x RJ-45 LAN ポート(ACT/LINK LED と SPEED LED)
- HD オーディオジャック: リアスピーカー / センター / バス / ラインイン / フロントスピーカー / マイク

ストレージ

- 4 x SATA3 6.0 Gb/s コネクタ, RAID(RAID 0, RAID 1, RAID 10)、NCQ、AHCI およびホットプラグ機能に対応
 - 1 x Ultra M.2 ソケット, M Key タイプ 2280 M.2 SATA3 6.0 Gb/s モジュール、および、最大 Gen3 x4 (32 Gb/s) (Ryzen シリーズ CPU の場合)または最大 Gen3 x2 (16 Gb/s) (A シリーズ APU の場合)までの M.2 PCI Express モジュールに対応 *
- * 起動ディスクとして NVMe SSD に対応

コネクタ

- 1 x LPC ヘッダー
 - 1 x AMD ファン LED ヘッダー
- * AMD ファン LED ヘッダーは、3A (36W) の最大負荷と 2.5M までの長さの LED ストリップに対応します。
- 1 x CPU ファンコネクタ (4 ピン)
- * CPU ファンコネクタは最大 1A (12W) の電力の CPU ファンに対応します。
- 1 x シャーシファンコネクタ (4 ピン)
 - 1 x シャーシ / ウォーターポンプファンコネクタ (4 ピン) (スマートファン速度制御)
- * シャーシ / ウォーターポンプファンは最大 1.5A (18W) の出力のウォータークーラーに対応します。
- 1 x 24 ピン ATX 電源コネクタ
 - 1 x 8 ピン 12V 電源コネクタ (高密度電源コネクタ)
 - 1 x 前面パネルオーディオコネクタ
 - 1 x AMD LED ファン USB ヘッダー
 - 1 x USB 2.0 ヘッダー (2 つの USB 2.0 ポートに対応) (静電気放電(ESD)保護に対応)
 - 1 x USB 3.1 Gen1 ヘッダー (2 つの USB 3.1 Gen1 ポートに対応) (静電気放電(ESD)保護に対応)

OS

- Microsoft® Windows® 10 64-bit

规格

平台

- Mini-ITX 规格尺寸
- 2 盎司纯铜电路板

CPU

- 支持 AMD Socket AM4 A 系列 APU (Bristol Ridge) 和锐龙 AMD Ryzen 处理器 (Summit Ridge、Raven Ridge 和 Pinnacle Ridge)
- Digi Power design
- 8 电源相设计
- 支持 105W 水冷散热 (Pinnacle Ridge)；支持 95W 水冷散热 (Summit Ridge)；支持 65W 水冷散热 (Raven Ridge)

芯片集

- AMD Promontory A320

内存

- 双通道 DDR4 内存技术
 - 2 x DDR4 DIMM 槽
 - AMD Ryzen 系列 CPU (Pinnacle Ridge) 支持 DDR4 3466+(OC)/3200(OC)/2933/2667/2400/2133 ECC 及非 ECC，非缓冲内存 *
 - AMD Ryzen 系列 CPU (Summit Ridge) 支持 DDR4 3466+(OC)/3200(OC)/2933(OC)/2667/2400/2133 ECC 及非 ECC，非缓冲内存 *
 - AMD Ryzen 系列 CPU (Raven Ridge) 支持 DDR4 3466+(OC)/3200(OC)/2933(OC)/2667/2400/2133 及非 ECC，非缓冲内存 *
 - AMD 7th Gen A 系列 APU 支持 DDR4 2400/2133 ECC 及非 ECC，非缓冲内存 *
- * 对于 Ryzen 系列 CPU (Raven Ridge)，仅 PRO CPU 支持 ECC。
- * 请参阅华擎网站上的 Memory Support List (内存支持列表) 了解详情。(http://www.asrock.com/)
- 支持系统内存最大容量：32GB
 - DIMM 插槽中 15 μ 金触点

扩充槽

- 锐龙 AMD Ryzen 处理器 (Summit Ridge 和 Pinnacle Ridge)**
- 1 x PCI Express 3.0 x16 插槽 (PCIE1：x16 模式) *
- AMD 7th Gen A 系列 APU / Raven Ridge**
- 1 x PCI Express 3.0 x16 插槽 (PCIE1：x8 模式) *
- * 支持 NVMe SSD 用作启动盘

图形

- Ryzen 系列 APU 中的集成 AMD Radeon™ Vega 系列图形 *
 - A 系列 APU 中的集成 AMD Radeon™ R 系列图形 *
- * 实际支持可能视 CPU 而变化
- DirectX 12、Pixel Shader 5.0
 - 最大共享内存 2GB
 - 支持 2 x HDMI，24Hz 时最大分辨率可达 4K x 2K (4096x2160)/30Hz 时可达 (3840x2160)
 - 通过 HDMI 端口（需要兼容的 HDMI 显示器）支持 Auto Lip Sync、Deep Color (12bpc)、xvYCC 和 HBR（高位速率音频）
 - 通过 HDMI 端口支持 HDCP
 - 通过 HDMI 端口支持全高清 1080p Blu-ray (BD) 播放

音频

- 具有内容保护功能的 7.1 CH 高清音频（Realtek ALC1220 音频编解码器）
- 优质 Blu-ray 音频支持
- 支持电涌保护
- Nichicon Fine Gold 系列音频电容
- 120dB SNR DAC，带微分放大器
- 纯电源输入
- Direct Drive（直接驱动）技术
- PCB 隔离罩
- 线路输出端口的阻抗感测
- 用于左 / 右音频通道的个别 PCB 层

LAN

- Gigabit LAN 10/100/1000 Mb/s
- GigaLAN Intel® I211AT
- 支持 Wake-On-LAN（网上唤醒）
- 支持雷电 /ESD 保护
- 支持高能效以太网 802.3az
- 支持 PXE

后面板 I/O

- 1 x PS/2 鼠标 / 键盘端口
- 2 x HDMI 端口
- 1 x 光学 SPDIF 输出端口
- 2 x USB 2.0 端口（支持 ESD 保护）
- 1 x USB 3.1 Gen1 A 类型端口（支持 ESD 保护）
- 1 x USB 3.1 Gen1 C 类型端口（支持 ESD 保护）
- 2 x USB 3.1 Gen1 端口（支持 ESD 保护）

- 1 x RJ-45 LAN 端口，带 LED（ACT/LINK LED 和 SPEED LED）
- 高清音频插孔：后扬声器 / 中央 / 低音 / 线路输入 / 前扬声器 / 麦克风

存储

- 4 x SATA3 6.0 Gb/s 接口，支持 RAID（RAID 0、RAID 1 和 RAID 10）、NCQ、AHCI 和热插拔
 - 1 x 超级 M.2 接口，支持 M Key 类型 2280 M.2 SATA3 6.0 Gb/s 模块和 M.2 PCI Express 模块（最高 Gen3 x4（32 Gb/s）（锐龙 AMD Ryzen 处理器）或 Gen3 x2（16 Gb/s）（A 系列 APU））*
- * 支持 NVMe SSD 用作启动盘

接口

- 1 x LPC 接脚
 - 1 x AMD 风扇 LED 接脚
- * AMD 风扇 LED 接脚支持最大负载为 3A（36W）、最大长度为 2.5 米的 LED 灯条。
- 1 x CPU 风扇接口（4 针）
- * CPU 风扇接口支持最高 1A（12W）功率的 CPU 风扇。
- 1 x 机箱风扇接口（4 针）
 - 1 x 机箱 / 水泵风扇接口（4 针）（智能风扇速度控制）
- * 机箱 / 水泵风扇支持最高 1.5A（18W）功率的水冷风扇。
- 1 x 24 针 ATX 电源接口
 - 1 x 8 针 12V 电源接口（高密度电源接口）
 - 1 x 前面板音频接口
 - 1 x AMD LED 风扇 USB 接脚
 - 1 x USB 2.0 接脚（支持 2 个 USB 2.0 端口，支持 ESD 保护）
 - 1 x USB 3.1 Gen1 接脚（支持 2 个 USB 3.1 Gen1 端口，支持 ESD 保护）

操作系统

- Microsoft® Windows® 10 64-bit

电子信息产品污染控制标示

依据中国发布的「电子信息产品污染控制管理办法」及 SJ/T 11364-2006「电子信息产品污染控制标示要求」，电子信息产品应进行标示，藉以向消费者揭露产品中含有的有毒有害物质或元素不致发生外泄或突变从而对环境造成污染或对人体、财产造成严重损害的期限。依上述规定，您可于本产品之印刷电路板上看见图一之标示。图一中之数字为产品之环保使用期限。由此可知此主板之环保使用期限为 10 年。



图一

有毒有害物质或元素的名称及含量说明

若您欲了解此产品的有毒有害物质或元素的名称及含量说明，请参照以下表格及说明。

部件名称	有害物质或元素					
	铅 (Pb)	镉 (Cd)	汞 (Hg)	六价铬 (Cr(VI))	多溴联苯 (PBB)	多溴二苯醚 (PBDE)
印刷电路板及电子组件	X	O	O	O	O	O
外部信号连接头及线材	X	O	O	O	O	O

O: 表示该有毒有害物质在该部件所有均质材料中的含量均在 SJ/T 11363-2006 标准规定的限量要求以下。

X: 表示该有毒有害物质至少在该部件的某一均质材料中的含量超出 SJ/T 11363-2006 标准规定的限量要求，然该部件仍符合欧盟指令 2002/95/EC 的规范。

备注: 此产品所标示之环保使用期限，系指在一般正常使用状况下。

規格

平台

- Mini-ITX 尺寸
- 2oz 銅製 PCB

CPU

- 支援 AMD Socket AM4 A 系列 APU (Bristol Ridge) 與 Ryzen 系列 CPU (Summit Ridge、Raven Ridge 及 Pinnacle Ridge)
- Digi Power design
- 8 電源相位設計
- 支援 105W 水冷 (Pinnacle Ridge)；支援 95W 水冷 (Summit Ridge)；支援 65W 水冷 (Raven Ridge)

晶片組

- AMD Promontory A320

記憶體

- 雙通道 DDR4 記憶體技術
 - 2 x DDR4 DIMM 插槽
 - AMD Ryzen 系列 CPU (Pinnacle Ridge) 支援 DDR4 3466+(OC)/3200(OC)/2933/2667/2400/2133 ECC & 非 ECC、無緩衝記憶體 *
 - AMD Ryzen 系列 CPU (Summit Ridge) 支援 DDR4 3466+(OC)/3200(OC)/2933(OC)/2667/2400/2133 ECC & 非 ECC、無緩衝記憶體 *
 - AMD Ryzen 系列 CPU (Raven Ridge) 支援 DDR4 3466+(OC)/3200(OC)/2933(OC)/2667/2400/2133 非 ECC、無緩衝記憶體 *
 - AMD 第 7 代 A 系列 APU 支援 DDR4 2400/2133 ECC & 非 ECC、無緩衝記憶體 *
- * 若使用 Ryzen 系列 CPU (Raven Ridge)，僅 PRO CPU 支援 ECC。
- * 如需更多資訊，請參閱華擎網站上的記憶體支援表。(http://www.asrock.com/)
- 最大系統記憶體容量：32GB
 - 15 μ 特厚鍍金插槽

擴充插槽

AMD Ryzen 系列 CPUs (Summit Ridge 及 Pinnacle Ridge)

- 1 x PCI Express 3.0 x16 插槽 (PCIe1：x16 模式)*

AMD 第 7 代 A 系列 APU / Raven Ridge

- 1 x PCI Express 3.0 x16 插槽 (PCIe1：x8 模式)*

* 支援 NVMe SSD 作為開機磁碟

顯示卡

- 整合式 AMD Radeon™ Vega Series Graphics 內建於 Ryzen 系列 APU*
 - 整合 A 系列 APU 的 AMD Radeon™ R 系列顯示卡*
- * 實際支援可能隨 CPU 改變
- DirectX 12、Pixel Shader 5.0
 - 最大共用記憶體 2GB
 - 支援最高可達 4K x 2K (4096x2160) @ 24Hz / (3840x2160) @ 30Hz 解析度的 2 x HDMI
 - 支援使用 HDMI 連接埠（需相容於 HDMI 監視器）的 Auto Lip Sync、Deep Color (12bpc)、xvYCC 及 HBR（高位元率音訊）
 - 支援含 HDMI 連接埠的 HDCP
 - 支援透過 HDMI 連接埠的 Full HD 1080p 藍光 (BD) 播放

音訊

- 7.1 CH HD 音訊含內容保護（Realtek ALC1220 音訊轉碼器）功能
- 高階藍光音訊支援
- 支援突波保護
- Nichicon Fine Gold 系列音響級電容
- 120dB SNR DAC 及差動放大器
- 純電源輸入
- 直驅技術
- PCB 隔離遮蔽
- 線路輸出埠的阻抗感應
- 適用左／右音訊聲道的獨立 PCB 層

LAN

- Gigabit LAN 10/100/1000 Mb/s
- GigaLAN Intel® I211AT
- 支援網路喚醒
- 支援雷擊／靜電保護
- 支援 Energy Efficient Ethernet 802.3az
- 支援 PXE

後面板 I/O

- 1 x PS/2 滑鼠／鍵盤連接埠
- 2 x HDMI 連接埠
- 1 x 光纖 SPDIF 輸出連接埠
- 2 x USB 2.0 連接埠（支援靜電保護）
- 1 x USB 3.1 Gen1 A 類型連接埠（支援靜電保護）

- 1 x USB 3.1 Gen1 C 類型連接埠（支援靜電保護）
- 2 x USB 3.1 Gen1 連接埠（支援靜電保護）
- 1 x RJ-45 LAN 連接埠，含 LED（ACT/LINK LED 及 SPEED LED）
- HD 音訊插孔：後置喇叭／中置／低音／線路輸入／前置喇叭／麥克風

儲存裝置

- 提供 4 x SATA3 6.0 Gb/s 接頭，支援 RAID（RAID 0、RAID 1、與 RAID 10）、NCQ、AHCI 及熱插拔
- 1 x Ultra M.2 插座，支援 M Key 型 2280 M.2 SATA3 6.0 Gb/s 模組與 M.2 PCI Express 模組（使用 Ryzen 系列 CPU 時，最高可達 Gen3 x4 (32 Gb/s)，或使用 A 系列 APU 時，最高可達 Gen3 x2 (16 Gb/s)）*

* 支援 NVMe SSD 作為開機磁碟

接頭

- 1 x LPC 排針
- 1 x AMD 風扇 LED 排針
- * AMD 風扇 LED 排針 LED 光條最大支援 3A (36W) 的負載和 2.5 公尺的長度。
- 1 x CPU 風扇接頭 (4-pin)
- * CPU 風扇接頭支援最高 1A (12W) 風扇功率的 CPU 風扇。
- 1 x 機殼風扇接頭 (4-pin)
- 1 x 機殼／水冷幫浦風扇接頭 (4-pin)（智慧型風扇速度控制）
- * 機殼／水冷幫浦風扇接頭支援最高 1.5A (18W) 風扇功率的水冷風扇。
- 1 x 24 pin ATX 電源接頭
- 1 x 8 pin 12V 電源接頭（高密度電源接頭）
- 1 x 前面板音訊接頭
- 1 x AMD LED 風扇 USB 排針
- 1 x USB 2.0 排針（支援 2 個 USB 2.0 連接埠）（支援靜電保護）
- 1 x USB 3.1 Gen1 排針（支援 2 個 USB 3.1 Gen1 連接埠）（支援靜電保護）

作業系統

- Microsoft® Windows® 10 64-bit

Spesifikasi

Platform

- Bentuk dan Ukuran Mini-ITX
- PCB Tembaga 2oz

CPU

- Mendukung Soket AMD APU Seri AM4 A (Bristol Ridge) dan CPU Seri Ryzen (Summit Ridge, Raven Ridge, dan Pinnacle Ridge)
- Digi Power design
- Desain 8 Fase Daya
- Mendukung Pendingin Air 105W (Pinnacle Ridge); Mendukung Pendingin Air 95W (Summit Ridge); Mendukung Pendingin Air 65W (Raven Ridge)

Chipset

- AMD Promontory A320

Memori

- Teknologi Memori DDR4 Dua Kanal
- 2 x Slot DIMM DDR4
- CPU seri AMD Ryzen (Pinnacle Ridge) mendukung DDR4 3466+(OC)/3200(OC)/2933/2667/2400/2133 ECC & non-ECC, memori tanpa buffer*
- CPU seri AMD Ryzen (Summit Ridge) mendukung memori tanpa buffer DDR4 3466+(OC)/3200(OC)/2933(OC)/2667/2400/2133 ECC & non-ECC*
- CPU seri AMD Ryzen (Raven Ridge) mendukung memori tanpa buffer DDR4 3466+(OC)/3200(OC)/2933(OC)/2667/2400/2133 non-ECC*
- APU AMD 7th Seri Gen A mendukung DDR4 2400/2133 ECC & non-ECC, memori tanpa buffer*

* Untuk CPU Seri Ryzen (Raven Ridge), ECC hanya didukung dengan CPU PRO.

* Lihat Daftar Dukungan Memori pada situs web ASRock untuk informasi selengkapnya. (<http://www.asrock.com/>)

- Kapasitas maksimum memori sistem: 32GB
- 15µ Bidang Kontak berwarna Emas di Slot DIMM

Slot Ekspansi

CPU seri AMD Ryzen (Summit Ridge dan Pinnacle Ridge)

- 1 x Slot PCI Express 3.0 x16 (PCIe1:x16 mode)*

APU AMD 7th Seri A / Raven Ridge

- 1 x Slot PCI Express 3.0 x16 (PCIe1:x8 mode)*

* Mendukung SSD NVMe sebagai disk boot

Grafis

- Grafis AMD Radeon™ Terpadu Seri Vega dalam APU Seri Ryzen*
 - Grafis AMD Radeon™ Seri R terpadu dalam APU seri A*
- * Dukungan sebenarnya mungkin beragam berdasarkan CPU
- DirectX 12, Pixel Shader 5.0
 - Maksimum memori bersama 2GB
 - Mendukung 2 x HDMI dengan resolusi maksimum hingga 4K x 2K (4096x2160) @ 24Hz/(3840x2160) @ 30Hz
 - Mendukung Auto Lip Sync, Kedalaman Warna (12bpc), xvYCC, dan HBR (Audio High Bit Rate) dengan Port HDMI (memerlukan monitor yang kompatibel dengan HDMI)
 - Mendukung fungsi HDCP dengan Port HDMI
 - Mendukung pemutaran Blu-ray (BD) 1080p Full HD dengan Port HDMI

Audio

- Audio HD 7.1 CH dengan Perlindungan Konten (Realtek ALC1220 Audio Codec)
- Mendukung Audio Blu-ray Premium
- Mendukung Perlindungan dari Arus Pendek
- Nichicon Fine Gold Series Audio Caps
- 120dB SNR DAC dengan Amplifier Diferensial
- Daya Masuk Kuat
- Teknologi Direct Drive
- Pelindung Terisolasi PCB
- Deteksi Impedansi pada port Saluran Keluar
- Lapisan PCB Individual untuk Saluran Audio Ka/Ki

LAN

- Gigabit LAN 10/100/1000 Mb/s
- GigaLAN Intel® I211AT
- Mendukung Wake-On-LAN
- Mendukung Perlindungan dari Petir/ESD
- Mendukung Ethernet Hemat Energi 802.3az
- Mendukung PXE

**I/O Panel
Belakang**

- 1 x Port Mouse/Keyboard PS/2
- 2 x Port HDMI
- 1 x Port SPDIF Out Optik
- 2 x Port USB 2.0 (Mendukung Perlindungan dari ESD)
- 1 x USB 3.1 Gen1 Port Tipe A (Mendukung Perlindungan dari ESD)

- 1 x USB 3.1 Gen1 Port Tipe C (Mendukung Perlindungan dari ESD)
- 2 x Port USB 3.1 Gen1 (Mendukung Perlindungan dari ESD)
- 1 x Port LAN RJ-45 dengan LED (LED ACT/LINK dan LED SPEED)
- Soket Audio HD: Speaker Belakang / Tengah / Bass / Jalur masuk / Speaker Depan / Mikrofon

Penyimpanan

- 4 x Konektor SATA3 6,0 Gb/s, mendukung RAID (RAID 0, RAID 1, dan RAID 10), NCQ, AHCI dan Hot Plug
- 1 x Soket Ultra M.2, mendukung jenis modul 2280 M.2 SATA3 6,0 Gb/s dan modul M.2 PCI Express hingga Gen3 x4 (32 Gb/s) (dengan CPU Ryzen) atau Generasi ke-3 x2 (16 Gb/s) (dengan APU seri A)*

* Mendukung SSD NVMe sebagai disk boot

Konektor

- 1 x Header LPC
- 1 x Kipas Header LED AMD
- * Kipas Header LED AMD mendukung LED strip dengan pemuatan maksimal 3A (36W) dan panjang hingga 2,5M.
- 1 x Konektor Kipas CPU (4-pin)
- * Konektor Kipas CPU mendukung kipas CPU dengan daya kipas maksimum 1A (12W).
- 1 x Konektor Kipas Chassis (4-pin)
- 1 x Konektor Sasis/Kipas Pompa Air (4-pin) (Kontrol Kecepatan Kipas Pintar)
- * Sasis/Kipas Pompa Air mendukung kipas berpendingin air dengan daya kipas maksimum 1,5A (18W).
- 1 x Konektor Daya ATX 24 pin
- 1 x Konektor Daya 12 V 8 pin (Konektor Daya dengan Kerapatan Tinggi)
- 1 x Konektor Audio Panel Depan
- 1 x Header USB Kipas LED AMD
- 1 x Header USB 2.0 (Mendukung 2 port USB 2.0) (Mendukung Perlindungan dari ESD)
- 1 x Header USB 3.1 Gen1 (Mendukung 2 port USB 3.1 Gen1) (Mendukung Perlindungan dari ESD)

OS

- Microsoft® Windows® 10 64-bit

Contact Information

If you need to contact ASRock or want to know more about ASRock, you're welcome to visit ASRock's website at <http://www.asrock.com>; or you may contact your dealer for further information. For technical questions, please submit a support request form at <https://event.asrock.com/tsd.asp>

ASRock Incorporation

2F., No.37, Sec. 2, Jhongyang S. Rd., Beitou District,

Taipei City 112, Taiwan (R.O.C.)

ASRock EUROPE B.V.

Bijsterhuizen 11-11

6546 AR Nijmegen

The Netherlands

Phone: +31-24-345-44-33

Fax: +31-24-345-44-38

ASRock America, Inc.

13848 Magnolia Ave, Chino, CA91710

U.S.A.

Phone: +1-909-590-8308

Fax: +1-909-590-1026

DECLARATION OF CONFORMITY

Per FCC Part 2 Section 2.1077(a)



Responsible Party Name: ASRock Incorporation

Address: 13848 Magnolia Ave, Chino, CA91710

Phone/Fax No: +1-909-590-8308/+1-909-590-1026

hereby declares that the product

Product Name : Motherboard

Model Number : A320M-ITX

Conforms to the following specifications:

FCC Part 15, Subpart B, Unintentional Radiators

Supplementary Information:

This device complies with part 15 of the FCC Rules. Operation is subject to the following two conditions: (1) This device may not cause harmful interference, and (2) this device must accept any interference received, including interference that may cause undesired operation.

Representative Person's Name: James

Signature :

A handwritten signature in black ink, appearing to read 'James', written over a horizontal line.

Date : May 12, 2017

EU Declaration of Conformity



For the following equipment:

Motherboard

(Product Name)

A320M-ITX / ASRock

(Model Designation / Trade Name)

ASRock Incorporation

(Manufacturer Name)

2F., No.37, Sec. 2, Jhongyang S. Rd., Beitou District, Taipei City 112, Taiwan (R.O.C.)

(Manufacturer Address)

EMC — Directive 2014/30/EU (from April 20th, 2016)

EN 55022:2010/AC:2011 Class B

EN 55024:2010/A1:2015

EN 55032:2012+AC:2013 Class B

EN 61000-3-3:2013

EN 61000-3-2:2014

LVD — Directive 2014/35/EU (from April 20th, 2016)

EN 60950-1 : 2011+ A2: 2013

EN 60950-1 : 2006/A12: 2011

RoHS — Directive 2011/65/EU

CE marking

(EU conformity marking)



ASRock EUROPE B.V.

(Company Name)

Bijsterhuizen 1111 6546 AR Nijmegen The Netherlands

(Company Address)

Person responsible for making this declaration:

(Name, Surname)

A.V.P

(Position / Title)

April 13, 2018

(Date)

P/N: 15G062095000AK V1.0