



P43DE

# User Manual

Version 1.0

Published October 2008

Copyright©2008 ASRock INC. All rights reserved.

---

### **Copyright Notice:**

No part of this manual may be reproduced, transcribed, transmitted, or translated in any language, in any form or by any means, except duplication of documentation by the purchaser for backup purpose, without written consent of ASRock Inc.

Products and corporate names appearing in this manual may or may not be registered trademarks or copyrights of their respective companies, and are used only for identification or explanation and to the owners' benefit, without intent to infringe.

### **Disclaimer:**

Specifications and information contained in this manual are furnished for informational use only and subject to change without notice, and should not be constructed as a commitment by ASRock. ASRock assumes no responsibility for any errors or omissions that may appear in this manual.

With respect to the contents of this manual, ASRock does not provide warranty of any kind, either expressed or implied, including but not limited to the implied warranties or conditions of merchantability or fitness for a particular purpose.

In no event shall ASRock, its directors, officers, employees, or agents be liable for any indirect, special, incidental, or consequential damages (including damages for loss of profits, loss of business, loss of data, interruption of business and the like), even if ASRock has been advised of the possibility of such damages arising from any defect or error in the manual or product.



This device complies with Part 15 of the FCC Rules. Operation is subject to the following two conditions:

- (1) this device may not cause harmful interference, and
- (2) this device must accept any interference received, including interference that may cause undesired operation.

### **CALIFORNIA, USA ONLY**

The Lithium battery adopted on this motherboard contains Perchlorate, a toxic substance controlled in Perchlorate Best Management Practices (BMP) regulations passed by the California Legislature. When you discard the Lithium battery in California, USA, please follow the related regulations in advance.

"Perchlorate Material-special handling may apply, see [www.dtsc.ca.gov/hazardouswaste/perchlorate](http://www.dtsc.ca.gov/hazardouswaste/perchlorate)"

**ASRock Website:** <http://www.asrock.com>

---

---

## Contents

<b>1 Introduction .....</b>	<b>5</b>
1.1 Package Contents .....	5
1.2 Specifications .....	6
1.3 Motherboard Layout .....	10
1.4 I/O Panel .....	11
<b>2 Installation .....</b>	<b>13</b>
2.1 Screw Holes .....	13
2.2 Pre-installation Precautions .....	13
2.3 CPU Installation .....	14
2.4 Installation of Heatsink and CPU fan .....	16
2.5 Installation of Memory Modules (DIMM) .....	17
2.6 Expansion Slots (PCI and PCI Express Slots) .....	19
2.7 Jumpers Setup .....	20
2.8 Onboard Headers and Connectors .....	21
2.9 HDMI_SPDIF Header Connection Guide .....	26
2.10 SATAII Hard Disk Setup Guide .....	27
2.11 Serial ATA (SATA) / Serial ATAII (SATAII) Hard Disks Installation .....	28
2.12 Hot Plug Function for SATA / SATAII HDDs .....	28
2.13 SATA / SATAII HDD Hot Plug Feature and Operation Guide .....	29
2.14 Driver Installation Guide .....	31
2.15 Installing Windows® 2000 / XP / XP 64-bit / Vista™/ Vista™ 64-bit Without RAID Functions .....	31
2.15.1 Installing Windows® 2000 / XP / XP 64-bit Without RAID Functions .....	31
2.15.2 Installing Windows® Vista™ / Vista™ 64-bit Without RAID Functions .....	32
2.16 Untied Overclocking Technology .....	33
<b>3 BIOS SETUP UTILITY .....</b>	<b>34</b>
3.1 Introduction .....	34
3.1.1 BIOS Menu Bar .....	34
3.1.2 Navigation Keys .....	35
3.2 Main Screen .....	35
3.3 Smart Screen .....	36
3.4 Advanced Screen .....	37
3.4.1 Overclock Configuration .....	37
3.4.2 CPU Configuration .....	40
3.4.3 Chipset Configuration .....	42



---

3.4.4 ACPI Configuration .....	45
3.4.5 IDE Configuration .....	46
3.4.6 PCI/PnP Configuration .....	48
3.4.7 Floppy Configuration .....	49
3.4.8 Super IO Configuration .....	49
3.4.9 USB Configuration .....	50
3.5 Hardware Health Event Monitoring Screen .....	51
3.6 Boot Screen .....	52
3.6.1 Boot Settings Configuration .....	52
3.7 Security Screen .....	53
3.8 Exit Screen .....	54
<b>4 Software Support .....</b>	<b>55</b>
4.1 Install Operating System .....	55
4.2 Support CD Information .....	55
4.2.1 Running Support CD .....	55
4.2.2 Drivers Menu .....	55
4.2.3 Utilities Menu .....	55
4.2.4 Contact Information .....	55



---

## Chapter 1: Introduction

Thank you for purchasing ASRock **P43DE** motherboard, a reliable motherboard produced under ASRock's consistently stringent quality control. It delivers excellent performance with robust design conforming to ASRock's commitment to quality and endurance.

In this manual, chapter 1 and 2 contain introduction of the motherboard and step-by-step guide to the hardware installation. Chapter 3 and 4 contain the configuration guide to BIOS setup and information of the Support CD.



Because the motherboard specifications and the BIOS software might be updated, the content of this manual will be subject to change without notice. In case any modifications of this manual occur, the updated version will be available on ASRock website without further notice. You may find the latest VGA cards and CPU support lists on ASRock website as well. ASRock website <http://www.asrock.com>  
If you require technical support related to this motherboard, please visit our website for specific information about the model you are using.  
[www.asrock.com/support/index.asp](http://www.asrock.com/support/index.asp)

### 1.1 Package Contents

ASRock **P43DE** Motherboard

(ATX Form Factor: 12.0-in x 8.5-in, 30.5 cm x 21.6 cm)

ASRock **P43DE** Quick Installation Guide

ASRock **P43DE** Support CD

One 80-conductor Ultra ATA 66/100/133 IDE Ribbon Cable

Two Serial ATA (SATA) Data Cables (Optional)

One Serial ATA (SATA) HDD Power Cable (Optional)

One I/O Panel Shield

## 1.2 Specifications

<b>Platform</b>	- ATX Form Factor: 12.0-in x 8.5-in, 30.5 cm x 21.6 cm
<b>CPU</b>	- LGA 775 for Intel® Core™ 2 Extreme / Core™ 2 Quad / Core™ 2 Duo / Pentium® Dual Core / Celeron® Dual Core / Celeron®, supporting Penryn Quad Core Yorkfield and Dual Core Wolfdale processors - Supports FSB1600/1333/1066/800 MHz - Supports Hyper-Threading Technology (see <b>CAUTION 1</b> ) - Supports Untied Overclocking Technology (see <b>CAUTION 2</b> ) - Supports EM64T CPU
<b>Chipset</b>	- Northbridge: Intel® P43 - Southbridge: Intel® ICH10
<b>Memory</b>	- Dual Channel DDR2 Memory Technology (see <b>CAUTION 3</b> ) - 4 x DDR2 DIMM slots - Support DDR2 1200/1066/800/667 non-ECC, un-buffered memory (see <b>CAUTION 4</b> ) - Max. capacity of system memory: 16GB (see <b>CAUTION 5</b> )
<b>Expansion Slot</b>	- 1 x PCI Express 2.0 x16 slot (green @ x16 mode) - 3 x PCI Express x1 slots - 2 x PCI slots
<b>Audio</b>	- 7.1 CH Windows® Vista™ Premium Level HD Audio (VIA® VT1708S Audio Codec)
<b>LAN</b>	- PCIe x1 Gigabit LAN 10/100/1000 Mb/s - Realtek RTL8111DL - Supports Wake-On-LAN
<b>Rear Panel I/O</b>	I/O Panel - 1 x PS/2 Mouse Port - 1 x PS/2 Keyboard Port - 1 x Coaxial SPDIF Out Port - 1 x Optical SPDIF Out Port - 6 x Ready-to-Use USB 2.0 Ports - 1 x RJ-45 LAN Port with LED (ACT/LINK LED and SPEED LED) - HD Audio Jack: Side Speaker/Rear Speaker/Central/Bass/Line in/Front Speaker/Microphone (see <b>CAUTION 6</b> )
<b>Connector</b>	- 6 x SATAII 3.0Gb/s connectors, support NCQ, AHCI and "Hot Plug" functions (see <b>CAUTION 7</b> ) - 1 x ATA133 IDE connector (supports 2 x IDE devices) - 1 x Floppy connector - 1 x IR header - 1 x COM port header

	<ul style="list-style-type: none"> <li>- 1 x HDMI_SPDIF header</li> <li>- CPU/Chassis FAN connector</li> <li>- 24 pin ATX power connector</li> <li>- 8 pin 12V power connector</li> <li>- CD in header</li> <li>- Front panel audio connector</li> <li>- 2 x USB 2.0 headers (support 4 USB 2.0 ports) (see <b>CAUTION 8</b>)</li> <li>- 1 x USB/WiFi header (see <b>CAUTION 9</b>)</li> </ul>
<b>BIOS Feature</b>	<ul style="list-style-type: none"> <li>- 8Mb AMI BIOS</li> <li>- AMI Legal BIOS</li> <li>- Supports "Plug and Play"</li> <li>- ACPI 1.1 Compliance Wake Up Events</li> <li>- Supports Jumperfree</li> <li>- AMBIOS 2.3.1 Support</li> <li>- CPU, DRAM, NB, SB, VTT Voltage Multi-adjustment</li> <li>- Supports I. O. T. (Intelligent Overclocking Technology)</li> <li>- Supports Smart BIOS</li> </ul>
<b>Support CD</b>	<ul style="list-style-type: none"> <li>- Drivers, Utilities, AntiVirus Software (Trial Version)</li> </ul>
<b>Unique Feature</b>	<ul style="list-style-type: none"> <li>- ASRock OC Tuner (see <b>CAUTION 10</b>)</li> <li>- Intelligent Energy Saver (see <b>CAUTION 11</b>)</li> <li>- Hybrid Booster: <ul style="list-style-type: none"> <li>- CPU Frequency Stepless Control (see <b>CAUTION 12</b>)</li> <li>- ASRock U-COP (see <b>CAUTION 13</b>)</li> <li>- Boot Failure Guard (B.F.G.)</li> </ul> </li> </ul>
<b>Hardware Monitor</b>	<ul style="list-style-type: none"> <li>- CPU Temperature Sensing</li> <li>- Chassis Temperature Sensing</li> <li>- CPU Fan Tachometer</li> <li>- Chassis Fan Tachometer</li> <li>- CPU Quiet Fan</li> <li>- Voltage Monitoring: +12V, +5V, +3.3V, CPU Vcore</li> </ul>
<b>OS</b>	<ul style="list-style-type: none"> <li>- Microsoft® Windows® 2000 / XP / XP 64-bit / Vista™ / Vista™ 64-bit compliant (see <b>CAUTION 14</b>)</li> </ul>
<b>Certifications</b>	<ul style="list-style-type: none"> <li>- FCC, CE, WHQL</li> </ul>

\* For detailed product information, please visit our website: <http://www.asrock.com>

#### **WARNING**

Please realize that there is a certain risk involved with overclocking, including adjusting the setting in the BIOS, applying Untied Overclocking Technology, or using the third-party overclocking tools. Overclocking may affect your system stability, or even cause damage to the components and devices of your system. It should be done at your own risk and expense. We are not responsible for possible damage caused by overclocking.

#### **CAUTION!**

1. About the setting of "Hyper Threading Technology", please check page 41.
2. This motherboard supports Untied Overclocking Technology. Please read "Untied Overclocking Technology" on page 33 for details.
3. This motherboard supports Dual Channel Memory Technology. Before you implement Dual Channel Memory Technology, make sure to read the installation guide of memory modules on page 17 for proper installation.
4. Please check the table below for the CPU FSB frequency and its corresponding memory support frequency.

CPU FSB Frequency	Memory Support Frequency
1600	DDR2 800, DDR2 1066, DDR2 1200 *
1333	DDR2 667, DDR2 800, DDR2 1066
1066	DDR2 667, DDR2 800, DDR2 1066
800	DDR2 667, DDR2 800

- \* DDR2 1200 memory modules will operate in overclocking mode.
5. Due to the operating system limitation, the actual memory size may be less than 4GB for the reservation for system usage under Windows® XP and Windows® Vista™. For Windows® XP 64-bit and Windows® Vista™ 64-bit with 64-bit CPU, there is no such limitation.
  6. For microphone input, this motherboard supports both stereo and mono modes. For audio output, this motherboard supports 2-channel, 4-channel, 6-channel, and 8-channel modes. Please check the table on page 11 for proper connection.
  7. Before installing SATAII hard disk to SATAII connector, please read the "SATAII Hard Disk Setup Guide" on page 27 to adjust your SATAII hard disk drive to SATAII mode. You can also connect SATA hard disk to SATAII connector directly.
  8. Power Management for USB 2.0 works fine under Microsoft® Windows® Vista™ 64-bit / Vista™ / XP 64-bit / XP SP1 or SP2 / 2000 SP4.
  9. USB/WiFi header can be used to support 2 USB 2.0 ports. It can also be used to support WiFi+AP function with ASRock WiFi-802.11g or WiFi-802.11n module, an easy-to-use wireless local area network (WLAN) adapter. It allows you to create a wireless environment and enjoy the convenience of wireless network connectivity. Please visit our website for the availability of ASRock WiFi-802.11g or WiFi-802.11n module. ASRock website <http://www.asrock.com>



- 
10. It is a user-friendly ASRock overclocking tool which allows you to surveil your system by hardware monitor function and overclock your hardware devices to get the best system performance under Windows® environment. Please visit our website for the operation procedures of ASRock OC Tuner. ASRock website: <http://www.asrock.com>
  11. Featuring an advanced proprietary hardware and software design, Intelligent Energy Saver is a revolutionary technology that delivers unparalleled power savings. In other words, it is able to provide exceptional power saving and improve power efficiency without sacrificing computing performance. Please visit our website for the operation procedures of Intelligent Energy Saver.  
ASRock website: <http://www.asrock.com>
  12. Although this motherboard offers stepless control, it is not recommended to perform over-clocking. Frequencies other than the recommended CPU bus frequencies may cause the instability of the system or damage the CPU.
  13. While CPU overheat is detected, the system will automatically shutdown. Before you resume the system, please check if the CPU fan on the motherboard functions properly and unplug the power cord, then plug it back again. To improve heat dissipation, remember to spray thermal grease between the CPU and the heatsink when you install the PC system.
  14. AHCI function is not supported under Windows® 2000 OS. It is recommended to use IDE mode under Windows® 2000. Please refer to page 46 for detailed setup.

### 1.3 Motherboard Layout

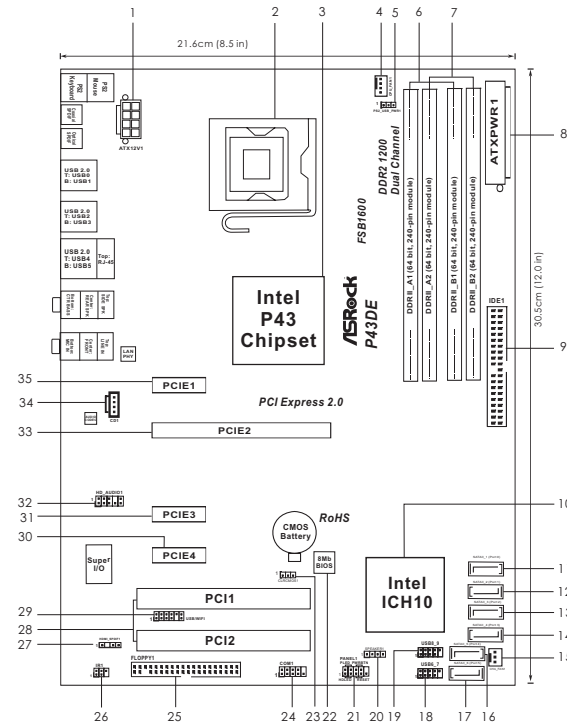

- |  |   |
|--|---|
| 1 ATX 12V Connector (ATX12V1)  | 19 USB 2.0 Header (USB8_9, Blue)              |
| 2 775-Pin CPU Socket   | 20 Chassis Speaker Header (SPEAKER 1, Purple) |
| 3 North Bridge Controller  | 21 System Panel Header (PANEL1, Orange)       |
| 4 CPU Fan Connector (CPU_FAN1)   | 22 SPI BIOS Chip                              |
| 5 PS2_USB_PWR1 Jumper  | 23 Clear CMOS Jumper (CLRCMOS1)               |
| 6 2 x 240-pin DDR2 DIMM Slots (Dual Channel A: DDRII_A1, DDRII_B1; Yellow) | 24 COM Port Header (COM1)                     |
| 7 2 x 240-pin DDR2 DIMM Slots (Dual Channel B: DDRII_A2, DDRII_B2; Orange) | 25 Floppy Connector (FLOPPY1)                 |
| 8 ATX Power Connector (ATXPWR1)  | 26 Infrared Module Header (IR1)               |
| 9 IDE1 Connector (IDE1, Blue)  | 27 HDMI_SPDIF Header (HDMI_SPDIF1, Yellow)    |
| 10 South Bridge Controller   | 28 PCI Slots (PCI1 - 2)                       |
| 11 SATAII Connector (SATAII_1 (Port0), Red)                                | 29 USB/WiFi Header (USB/WIFI, Yellow)         |
| 12 SATAII Connector (SATAII_2 (Port1), Red)                                | 30 PCI Express x1 Slot (PCIE4)                |
| 13 SATAII Connector (SATAII_3 (Port2), Red)                                | 31 PCI Express x1 Slot (PCIE3)                |
| 14 SATAII Connector (SATAII_4 (Port3), Red)                                | 32 Front Panel Audio Header (HD_AUDIO1, Lime) |
| 15 Chassis Fan Connector (CHA_FAN1)  | 33 PCI Express 2.0 x16 Slot (PCIE2, Green)    |
| 16 SATAII Connector (SATAII_5 (Port4), Red)                                | 34 Internal Audio Connector: CD1 (Black)      |
| 17 SATAII Connector (SATAII_6 (Port5), Red)                                | 35 PCI Express x1 Slot (PCIE1)                |
| 18 USB 2.0 Header (USB6_7, Blue)   |   |

## 1.4 I/O Panel

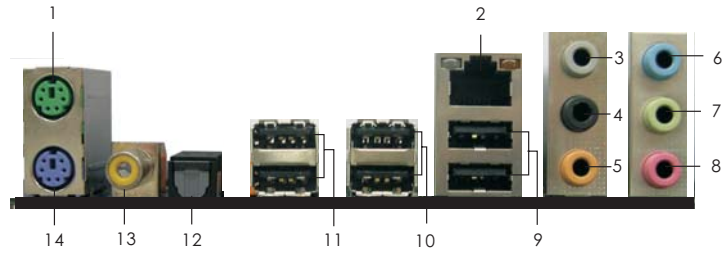

- |                           |                                |
|---------------------------|--------------------------------|
| 1 PS/2 Mouse Port (Green) | 8 Microphone (Pink)            |
| * 2 LAN RJ-45 Port (LAN1) | 9 USB 2.0 Ports (USB45)        |
| 3 Side Speaker (Gray)     | 10 USB 2.0 Ports (USB23)       |
| 4 Rear Speaker (Black)    | 11 USB 2.0 Ports (USB01)       |
| 5 Central / Bass (Orange) | 12 Optical SPDIF Out Port      |
| 6 Line In (Light Blue)    | 13 Coaxial SPDIF Out Port      |
| ** 7 Front Speaker (Lime) | 14 PS/2 Keyboard Port (Purple) |

\* There are two LED next to the LAN port. Please refer to the table below for the LAN port LED indications.

### LAN Port LED Indications

Activity/Link LED		SPEED LED		
Status	Description	Status	Description	
Off	No Activity	Off	10Mbps connection	 LAN Port
Blinking	Data Activity	Orange	100Mbps connection	
		Green	1Gbps connection	

\*\* If you use 2-channel speaker, please connect the speaker's plug into "Front Speaker Jack". See the table below for connection details in accordance with the type of speaker you use.

**TABLE for Audio Output Connection**

Audio Output Channels	Front Speaker (No. 7)	Rear Speaker (No. 4)	Central / Bass (No. 5)	Side Speaker (No. 3)
2	V	--	--	--
4	V	V	--	--
6	V	V	V	--
8	V	V	V	V

To enable Multi-Streaming function, you need to connect a front panel audio cable to the front panel audio header. After restarting your computer, you will find "VIA HD Audio Deck" tool on your system. Please follow below instructions according to the OS you install.

**For Windows® 2000 / XP / XP 64-bit OS:**

Please click "VIA HD Audio Deck" icon  , and click "Speaker". Then you are allowed to select "2 Channel", "4 Channel", "6 Channel" or "8 Channel". Click "Power" to save your change.

**For Windows® XP / XP 64-bit OS:**

Please click "VIA HD Audio Deck" icon  , and click "Advanced Options" on the left side on the bottom. In "Advanced Options" screen, select "Independent Headphone", and click "OK" to save your change.

If you enable Multi-Streaming function, Side Speaker function will be disabled. You can only choose to enable either Multi-Streaming function or Side Speaker function.

---

## Chapter 2: Installation

This is an ATX form factor (12.0" x 8.5", 30.5 x 21.6 cm) motherboard. Before you install the motherboard, study the configuration of your chassis to ensure that the motherboard fits into it.



Make sure to unplug the power cord before installing or removing the motherboard. Failure to do so may cause physical injuries to you and damages to motherboard components.

### 2.1 Screw Holes

Place screws into the holes indicated by circles to secure the motherboard to the chassis.



Do not over-tighten the screws! Doing so may damage the motherboard.

### 2.2 Pre-installation Precautions

Take note of the following precautions before you install motherboard components or change any motherboard settings.

1. Unplug the power cord from the wall socket before touching any component.
2. To avoid damaging the motherboard components due to static electricity, NEVER place your motherboard directly on the carpet or the like. Also remember to use a grounded wrist strap or touch a safety grounded object before you handle components.
3. Hold components by the edges and do not touch the ICs.
4. Whenever you uninstall any component, place it on a grounded antistatic pad or in the bag that comes with the component.



Before you install or remove any component, ensure that the power is switched off or the power cord is detached from the power supply. Failure to do so may cause severe damage to the motherboard, peripherals, and/or components.

## 2.3 CPU Installation

For the installation of Intel 775-LAND CPU, please follow the steps below.

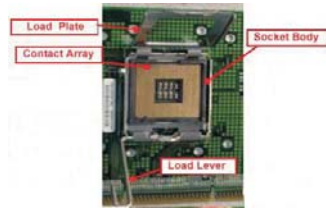

775-Pin Socket Overview



Before you insert the 775-LAND CPU into the socket, please check if the CPU surface is unclean or if there is any bent pin on the socket. Do not force to insert the CPU into the socket if above situation is found. Otherwise, the CPU will be seriously damaged.

### Step 1. Open the socket:

Step 1-1. Disengaging the lever by depressing down and out on the hook to clear retention tab.



Step 1-2. Rotate the load lever to fully open position at approximately 135 degrees.

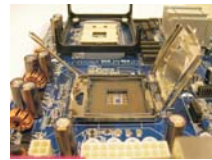

Step 1-3. Rotate the load plate to fully open position at approximately 100 degrees.

### Step 2. Insert the 775-LAND CPU:

Step 2-1. Hold the CPU by the edges where are marked with black lines.



Step 2-2. Orient the CPU with IHS (Integrated Heat Sink) up. Locate Pin1 and the two orientation key notches.

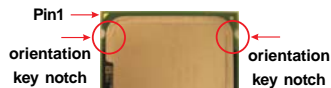

775-LAND CPU

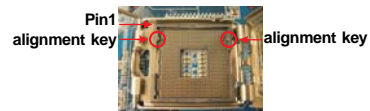

775-Pin Socket



For proper inserting, please ensure to match the two orientation key notches of the CPU with the two alignment keys of the socket.

Step 2-3. Carefully place the CPU into the socket by using a purely vertical motion.

Step 2-4. Verify that the CPU is within the socket and properly mated to the orient keys.



Step 3. Remove PnP Cap (Pick and Place Cap):

Use your left hand index finger and thumb to support the load plate edge, engage PnP cap with right hand thumb and peel the cap from the socket while pressing on center of PnP cap to assist in removal.



1. It is recommended to use the cap tab to handle and avoid kicking off the PnP cap.
2. This cap must be placed if returning the motherboard for after service.

Step 4. Close the socket:

Step 4-1. Rotate the load plate onto the IHS.

Step 4-2. While pressing down lightly on load plate, engage the load lever.

Step 4-3. Secure load lever with load plate tab under retention tab of load lever.



## 2.4 Installation of CPU Fan and Heatsink

This motherboard is equipped with 775-Pin socket that supports Intel 775-LAND CPU. Please adopt the type of heatsink and cooling fan compliant with Intel 775-LAND CPU to dissipate heat. Before you installed the heatsink, you need to spray thermal interface material between the CPU and the heatsink to improve heat dissipation. Ensure that the CPU and the heatsink are securely fastened and in good contact with each other. Then connect the CPU fan to the CPU\_FAN connector (CPU\_FAN1, see page 10, No. 4).

**For proper installation, please kindly refer to the instruction manuals of your CPU fan and heatsink.**

Below is an example to illustrate the installation of the heatsink for 775-LAND CPU.

Step 1. Apply thermal interface material onto center of IHS on the socket surface.



Step 2. Place the heatsink onto the socket. Ensure fan cables are oriented on side closest to the CPU fan connector on the motherboard (CPU\_FAN1, see page 10, No. 4).



Step 3. Align fasteners with the motherboard throughholes.

Step 4. Rotate the fastener clockwise, then press down on fastener caps with thumb to install and lock. Repeat with remaining fasteners.



If you press down the fasteners without rotating them clockwise, the heatsink cannot be secured on the motherboard.

Step 5. Connect fan header with the CPU fan connector on the motherboard.

Step 6. Secure excess cable with tie-wrap to ensure cable does not interfere with fan operation or contact other components.



## 2.5 Installation of Memory Modules (DIMM)

This motherboard provides four 240-pin DDR2 (Double Data Rate 2) DIMM slots, and supports Dual Channel Memory Technology. For dual channel configuration, you always need to install **identical** (the same brand, speed, size and chip-type) DDR2 DIMM pair in the slots of the same color. In other words, you have to install **identical** DDR2 DIMM pair in **Dual Channel A** (DDRII\_A1 and DDRII\_B1; Yellow slots; see p.10 No.6) or **identical** DDR2 DIMM pair in **Dual Channel B** (DDRII\_A2 and DDRII\_B2; Orange slots; see p.10 No.7), so that Dual Channel Memory Technology can be activated. This motherboard also allows you to install four DDR2 DIMMs for dual channel configuration, and please install **identical** DDR2 DIMMs in all four slots. You may refer to the Dual Channel Memory Configuration Table below.

**Dual Channel Memory Configurations**

	DDRII_A1 (Yellow Slot)	DDRII_A2 (Orange Slot)	DDRII_B1 (Yellow Slot)	DDRII_B2 (Orange Slot)
(1)	Populated	-	Populated	-
(2)	-	Populated	-	Populated
(3)*	Populated	Populated	Populated	Populated

\* For the configuration (3), please install **identical** DDR2 DIMMs in all four slots.



1. If you want to install two memory modules, for optimal compatibility and reliability, it is recommended to install them in the slots of the same color. In other words, install them either in the set of yellow slots (DDRII\_A1 and DDRII\_B1), or in the set of orange slots (DDRII\_A2 and DDRII\_B2).
2. If only one memory module or three memory modules are installed in the DDR2 DIMM slots on this motherboard, it is unable to activate the Dual Channel Memory Technology.
3. If a pair of memory modules is NOT installed in the same Dual Channel, for example, installing a pair of memory modules in DDRII\_A1 and DDRII\_A2, it is unable to activate the Dual Channel Memory Technology .
4. It is not allowed to install a DDR memory module into DDR2 slot; otherwise, this motherboard and DIMM may be damaged.

---

## Installing a DIMM



Please make sure to disconnect power supply before adding or removing DIMMs or the system components.

- Step 1. Unlock a DIMM slot by pressing the retaining clips outward.  
Step 2. Align a DIMM on the slot such that the notch on the DIMM matches the break on the slot.

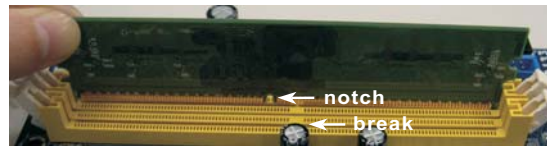
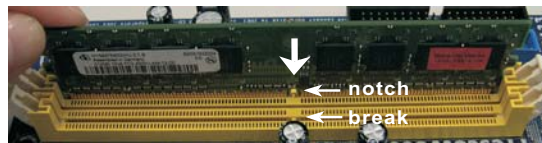

The DIMM only fits in one correct orientation. It will cause permanent damage to the motherboard and the DIMM if you force the DIMM into the slot at incorrect orientation.

- Step 3. Firmly insert the DIMM into the slot until the retaining clips at both ends fully snap back in place and the DIMM is properly seated.

---

## 2.6 Expansion Slots (PCI and PCI Express Slots)

There are 2 PCI slots and 4 PCI Express slots on this motherboard.

**PCI Slots:** PCI slots are used to install expansion cards that have the 32-bit PCI interface.

**PCI Express Slots:** PCI Express x1 slot (White) is used for PCI Express cards with x1 lane width cards, such as Gigabit LAN card, SATA2 card, etc.

PCI Express x16 slot (Green) is used for PCI Express x16 lane width graphics cards.

### Installing an expansion card

- Step 1. Before installing the expansion card, please make sure that the power supply is switched off or the power cord is unplugged. Please read the documentation of the expansion card and make necessary hardware settings for the card before you start the installation.
- Step 2. Remove the system unit cover (if your motherboard is already installed in a chassis).
- Step 3. Remove the bracket facing the slot that you intend to use. Keep the screws for later use.
- Step 4. Align the card connector with the slot and press firmly until the card is completely seated on the slot.
- Step 5. Fasten the card to the chassis with screws.
- Step 6. Replace the system cover.

## 2.7 Jumpers Setup

The illustration shows how jumpers are setup.

When the jumper cap is placed on pins, the jumper is "Short". If no jumper cap is placed on pins, the jumper is "Open". The illustration shows a 3-pin jumper whose pin1 and pin2 are "Short" when jumper cap is placed on these 2 pins.

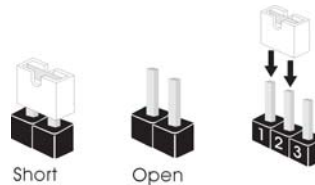

Jumper	Setting	Description
PS2_USB_PWR1 (see p.10 No. 5)	<div style="display: flex; justify-content: space-around;"> <div style="text-align: center;"> <p>1_2</p> <p>+5V</p> </div> <div style="text-align: center;"> <p>2_3</p> <p>+5VSB</p> </div> </div>	Short pin2, pin3 to enable +5VSB (standby) for PS/2 or USB wake up events.

Note: To select +5VSB, it requires 2 Amp and higher standby current provided by power supply.

Clear CMOS Jumper (CLRCMOS1) (see p.10 No. 23)	<div style="display: flex; justify-content: space-around;"> <div style="text-align: center;"> <p>1_2</p> <p>Default</p> </div> <div style="text-align: center;"> <p>2_3</p> <p>Clear CMOS</p> </div> </div>
--	---

Note: CLRCMOS1 allows you to clear the data in CMOS. The data in CMOS includes system setup information such as system password, date, time, and system setup parameters. To clear and reset the system parameters to default setup, please turn off the computer and unplug the power cord from the power supply. After waiting for 15 seconds, use a jumper cap to short pin2 and pin3 on CLRCMOS1 for 5 seconds. However, please do not clear the CMOS right after you update the BIOS. If you need to clear the CMOS when you just finish updating the BIOS, you must boot up the system first, and then shut it down before you do the clear-CMOS action.

## 2.8 Onboard Headers and Connectors



Onboard headers and connectors are NOT jumpers. Do NOT place jumper caps over these headers and connectors. Placing jumper caps over the headers and connectors will cause permanent damage of the motherboard!

FDD connector  
(33-pin FLOPPY1)  
(see p.10 No. 25)



Note: Make sure the red-striped side of the cable is plugged into Pin1 side of the connector.

Primary IDE connector (Blue)  
(39-pin IDE1, see p.10 No. 9)



connect the blue end to the motherboard

connect the black end to the IDE devices

80-conductor ATA 66/100/133 cable

Note: Please refer to the instruction of your IDE device vendor for the details.

### Serial ATAII Connectors

(SATAII\_1 (Port 0):  
see p.10, No. 11)  
(SATAII\_2 (Port 1):  
see p.10, No. 12)  
(SATAII\_3 (Port 2):  
see p.10, No. 13)  
(SATAII\_4 (Port 3):  
see p.10, No. 14)  
(SATAII\_5 (Port 4):  
see p.10, No. 16)  
(SATAII\_6 (Port 5):  
see p.10, No. 17)

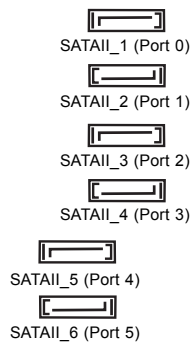

These six Serial ATAII (SATAII) connectors support SATA data cables for internal storage devices. The current SATAII interface allows up to 3.0 Gb/s data transfer rate.

Serial ATA (SATA)  
Data Cable  
(Optional)



Either end of the SATA data cable can be connected to the SATA / SATAII hard disk or the SATAII connector on this motherboard.

**Serial ATA (SATA)  
Power Cable  
(Optional)**

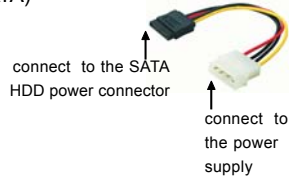

Please connect the black end of SATA power cable to the power connector on each drive. Then connect the white end of SATA power cable to the power connector of the power supply.

**USB 2.0 Headers**

(9-pin USB8\_9)  
(see p.10 No. 19)

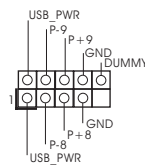

Besides six default USB 2.0 ports on the I/O panel, there are two USB 2.0 headers on this motherboard. Each USB 2.0 header can support two USB 2.0 ports.

(9-pin USB6\_7)  
(see p.10 No. 18)

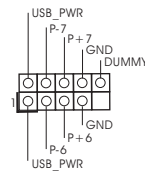

**USB/WiFi Header**

(11-pin USB/WIFI)  
(see p.10 No. 29)

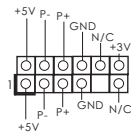

This header can be used to support 2 USB 2.0 ports. It can also be used to support WiFi+AP function with ASRock WiFi-802.11g or WiFi-802.11n module, an easy-to-use wireless local area network (WLAN) adapter. It allows you to create a wireless environment and enjoy the convenience of wireless network connectivity.

**Infrared Module Header**

(5-pin IR1)  
(see p.10 No. 26)

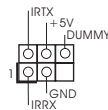

This header supports an optional wireless transmitting and receiving infrared module.

**Internal Audio Connectors**

(4-pin CD1)  
(see p.10 No. 34)

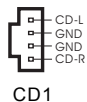

This connector allows you to receive stereo audio input from sound sources such as a CD-ROM, DVD-ROM, TV tuner card, or MPEG card.

### Front Panel Audio Header

(9-pin HD\_AUDIO1)  
(see p.10 No. 32)

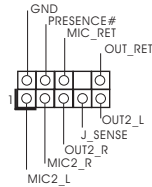

This is an interface for front panel audio cable that allows convenient connection and control of audio devices.



1. High Definition Audio supports Jack Sensing, but the panel wire on the chassis must support HDA to function correctly. Please follow the instruction in our manual and chassis manual to install your system.
2. If you use AC'97 audio panel, please install it to the front panel audio header as below:
  - A. Connect Mic\_IN (MIC) to MIC2\_L.
  - B. Connect Audio\_R (RIN) to OUT2\_R and Audio\_L (LIN) to OUT2\_L.
  - C. Connect Ground (GND) to Ground (GND).
  - D. MIC\_RET and OUT\_RET are for HD audio panel only. You don't need to connect them for AC'97 audio panel.
  - E. Enter BIOS Setup Utility. Enter Advanced Settings, and then select Chipset Configuration. Set the Front Panel Control option from [Auto] to [Enabled].

### System Panel Header

(9-pin PANEL1)  
(see p.10 No. 21)

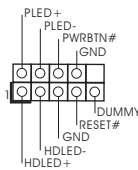

This header accommodates several system front panel functions.

### Chassis Speaker Header

(4-pin SPEAKER 1)  
(see p.10 No. 20)

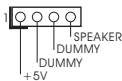

Please connect the chassis speaker to this header.

### Chassis Fan Connector

(3-pin CHA\_FAN1)  
(see p.10 No. 15)

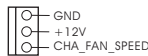

Please connect a chassis fan cable to this connector and match the black wire to the ground pin.

### CPU Fan Connector

(4-pin CPU\_FAN1)  
(see p.10, No. 4)

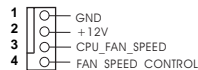

Please connect a CPU fan cable to this connector and match the black wire to the ground pin.



Though this motherboard provides 4-Pin CPU fan (Quiet Fan) support, the 3-Pin CPU fan still can work successfully even without the fan speed control function. If you plan to connect the 3-Pin CPU fan to the CPU fan connector on this motherboard, please connect it to Pin 1-3.

**Pin 1-3 Connected**  
3-Pin Fan Installation

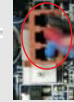

**ATX Power Connector**  
(24-pin ATXPWR1)  
(see p.10 No. 8)

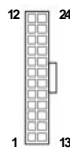

Please connect an ATX power supply to this connector.



Though this motherboard provides 24-pin ATX power connector, it can still work if you adopt a traditional 20-pin ATX power supply. To use the 20-pin ATX power supply, please plug your power supply along with Pin 1 and Pin 13.

20-Pin ATX Power Supply Installation

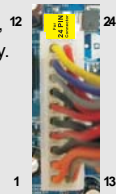

**ATX 12V Power Connector**  
(8-pin ATX12V1)  
(see p.10 No. 1)



Please connect an ATX 12V power supply to this connector.



Though this motherboard provides 8-pin ATX 12V power connector, it can still work if you adopt a traditional 4-pin ATX 12V power supply. To use the 4-pin ATX power supply, please plug your power supply along with Pin 1 and Pin 5.

4-Pin ATX 12V Power Supply Installation



**Serial port Header**  
(9-pin COM1)  
(see p.10 No. 24)

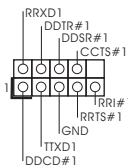

This COM1 header supports a serial port module.



**HDMI\_SPDIF Header**  
 (3-pin HDMI\_SPDIF1)  
 (see p.10 No. 27)



HDMI\_SPDIF header, providing SPDIF audio output to HDMI VGA card, allows the system to connect HDMI Digital TV/ projector/LCD devices. Please connect the HDMI\_SPDIF connector of HDMI VGA card to this header.

**HDMI\_SPDIF Cable**  
 (Optional)

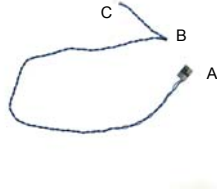

Please connect the black end (A) of HDMI\_SPDIF cable to the HDMI\_SPDIF header on the motherboard. Then connect the white end (B or C) of HDMI\_SPDIF cable to the HDMI\_SPDIF connector of HDMI VGA card.

**A. black end**



**B. white end (2-pin)**

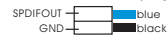

**C. white end (3-pin)**

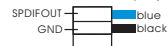

## 2.9 HDMI\_SPDIF Header Connection Guide

HDMI (High-Definition Multi-media Interface) is an all-digital audio/video specification, which provides an interface between any compatible digital audio/video source, such as a set-top box, DVD player, A/V receiver and a compatible digital audio or video monitor, such as a digital television (DTV). A complete HDMI system requires a HDMI VGA card and a HDMI ready motherboard with a HDMI\_SPDIF header. This motherboard is equipped with a HDMI\_SPDIF header, which provides SPDIF audio output to HDMI VGA card, allows the system to connect HDMI Digital TV/projector/LCD devices. To use HDMI function on this motherboard, please carefully follow the below steps.

Step 1. Install the HDMI VGA card to the PCI Express Graphics slot on this motherboard. For the proper installation of HDMI VGA card, please refer to the installation guide on page 19.

Step 2. Connect the black end (A) of HDMI\_SPDIF cable to the HDMI\_SPDIF header (HDMI\_SPDIF1, yellow, see page 10, No. 27) on the motherboard.



Make sure to correctly connect the HDMI\_SPDIF cable to the motherboard and the HDMI VGA card according to the same pin definition. For the pin definition of HDMI\_SPDIF header and HDMI\_SPDIF cable connectors, please refer to page 25. For the pin definition of HDMI\_SPDIF connectors on HDMI VGA card, please refer to the user manual of HDMI VGA card vendor. Incorrect connection may cause permanent damage to this motherboard and the HDMI VGA card.

Step 3. Connect the white end (B or C) of HDMI\_SPDIF cable to the HDMI\_SPDIF connector of HDMI VGA card. (There are two white ends (2-pin and 3-pin) on HDMI\_SPDIF cable. Please choose the appropriate white end according to the HDMI\_SPDIF connector of the HDMI VGA card you install.



white end  
(2-pin) (B)



white end  
(3-pin) (C)

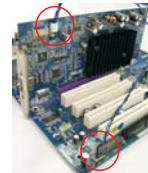

Please do not connect the white end of HDMI\_SPDIF cable to the wrong connector of HDMI VGA card or other VGA card. Otherwise, the motherboard and the VGA card may be damaged. For example, this picture shows the wrong example of connecting HDMI\_SPDIF cable to the fan connector of PCI Express VGA card. Please refer to the VGA card user manual for connector usage in advance.



Step 4. Connect the HDMI output connector on HDMI VGA card to HDMI device, such as HDTV. Please refer to the user manual of HDTV and HDMI VGA card vendor for detailed connection procedures.



Step 5. Install HDMI VGA card driver to your system.

## 2.10 SATAII Hard Disk Setup Guide

Before installing SATAII hard disk to your computer, please carefully read below SATAII hard disk setup guide. Some default setting of SATAII hard disks may not be at SATAII mode, which operate with the best performance. In order to enable SATAII function, please follow the below instruction with different vendors to correctly adjust your SATAII hard disk to SATAII mode in advance; otherwise, your SATAII hard disk may fail to run at SATAII mode.

### Western Digital

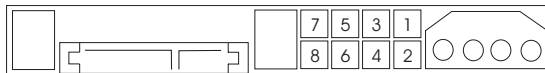

If pin 5 and pin 6 are shorted, SATA 1.5Gb/s will be enabled.

On the other hand, if you want to enable SATAII 3.0Gb/s, please remove the jumpers from pin 5 and pin 6.

### SAMSUNG



If pin 3 and pin 4 are shorted, SATA 1.5Gb/s will be enabled.

On the other hand, if you want to enable SATAII 3.0Gb/s, please remove the jumpers from pin 3 and pin 4.

### HITACHI

Please use the Feature Tool, a DOS-bootable tool, for changing various ATA features. Please visit HITACHI's website for details:

<http://www.hitachigst.com/hdd/support/download.htm>



The above examples are just for your reference. For different SATAII hard disk products of different vendors, the jumper pin setting methods may not be the same. Please visit the vendors' website for the updates.

---

## 2.11 Serial ATA (SATA) / Serial ATAII (SATAII) Hard Disks Installation

**P43DE** adopts Intel® ICH10 south bridge chipset that supports Serial ATA (SATA) / Serial ATAII (SATAII) hard disks. You may install SATA / SATAII hard disks on this motherboard for internal storage devices. This section will guide you to install the SATA / SATAII hard disks.

- STEP 1: Install the SATA / SATAII hard disks into the drive bays of your chassis.  
STEP 2: Connect the SATA power cable to the SATA / SATAII hard disk.  
STEP 3: Connect one end of the SATA data cable to the motherboard's SATAII connector.  
STEP 4: Connect the other end of the SATA data cable to the SATA / SATAII hard disk.



It is not recommended to switch the "Configure SATAII as" setting after OS installation.

## 2.12 Hot Plug Function for SATA / SATAII HDDs

**P43DE** supports Hot Plug function for SATA / SATAII Devices in AHCI mode. Intel® ICH10 south bridge chipset provides hardware support for Advanced Host controller Interface (AHCI), a new programming interface for SATA host controllers developed through a joint industry effort.



### NOTE

#### What is Hot Plug Function?

If the SATA / SATAII HDDs are NOT set for RAID configuration, it is called "Hot Plug" for the action to insert and remove the SATA / SATAII HDDs while the system is still power-on and in working condition. However, please note that it cannot perform Hot Plug if the OS has been installed into the SATA / SATAII HDD.

## 2.13 SATA / SATAII HDD Hot Plug Feature and Operation Guide

This motherboard supports Hot Plug feature for SATA / SATAII HDD in AHCI mode. Please read below operation guide of SATA / SATAII HDD Hot Plug feature carefully. Before you process the SATA / SATAII HDD Hot Plug, please check below cable accessories from the motherboard gift box pack.

A. 7-pin SATA data cable

B. SATA power cable with SATA 15-pin power connector interface

A. SATA data cable (Red)

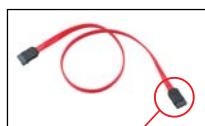

SATA 7-pin connector

B. SATA power cable



The SATA 15-pin power connector (Black) connect to SATA / SATAII HDD

1x4-pin conventional power connector (White) connect to power supply

### Caution

1. Without SATA 15-pin power connector interface, the SATA / SATAII Hot Plug cannot be processed.
2. Even some SATA / SATAII HDDs provide both SATA 15-pin power connector and IDE 1x4-pin conventional power connector interfaces, the IDE 1x4-pin conventional power connector interface is definitely not able to support Hot Plug and will cause the HDD damage and data loss.

### Points of attention, before you process the Hot Plug:

1. Below operation procedure is designed only for our motherboard, which supports SATA / SATAII HDD Hot Plug.
  - \* The SATA / SATAII Hot Plug feature might not be supported by the chipset because of its limitation, the SATA / SATAII Hot Plug support information of our motherboard is indicated in the product spec on our website:  
[www.asrock.com](http://www.asrock.com)
2. Make sure your SATA / SATAII HDD can support Hot Plug function from your dealer or HDD user manual. The SATA / SATAII HDD, which cannot support Hot Plug function, will be damaged under the Hot Plug operation.
3. Please make sure the SATA / SATAII driver is installed into system properly. The latest SATA / SATAII driver is available on our support website:  
[www.asrock.com](http://www.asrock.com)
4. Make sure to use the SATA power cable & data cable, which are from our motherboard package.
5. Please follow below instructions step by step to reduce the risk of HDD crash or data loss.

## How to Hot Plug a SATA / SATAII HDD:

Points of attention, before you process the Hot Plug:

Please do follow below instruction sequence to process the Hot Plug, improper procedure will cause the SATA / SATAII HDD damage and data loss.

**Step 1** Please connect SATA power cable 1x4-pin end (White) to the power supply 1x4-pin cable.

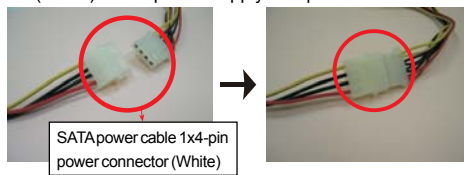

**Step 2** Connect SATA data cable to the motherboard's SATAII connector.

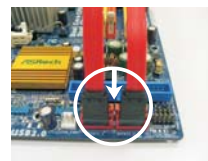

**Step 3** Connect SATA 15-pin power cable connector (Black) end to SATA / SATAII HDD.



**Step 4** Connect SATA data cable to the SATA / SATAII HDD.



## How to Hot Unplug a SATA / SATAII HDD:

Points of attention, before you process the Hot Unplug:

Please do follow below instruction sequence to process the Hot Unplug, improper procedure will cause the SATA / SATAII HDD damage and data loss.

**Step 1** Unplug SATA data cable from SATA / SATAII HDD side.

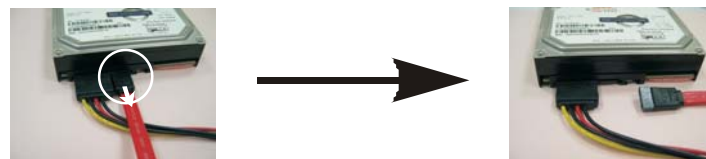

**Step 2** Unplug SATA 15-pin power cable connector (Black) from SATA / SATAII HDD side.

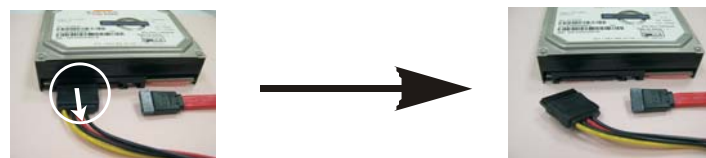

---

## 2.14 Driver Installation Guide

To install the drivers to your system, please insert the support CD to your optical drive first. Then, the drivers compatible to your system can be auto-detected and listed on the support CD driver page. Please follow the order from up to bottom side to install those required drivers. Therefore, the drivers you install can work properly.

## 2.15 Installing Windows® 2000 / XP / XP 64-bit / Vista™ / Vista™ 64-bit Without RAID Functions

If you want to install Windows® 2000 / XP / XP 64-bit / Vista™ / Vista™ 64-bit OS on your SATA / SATAII HDDs without RAID functions, please follow below procedures according to the OS you install.



Since Windows® 2000 AHCI driver is not provided by the chipset vendor, AHCI function is not supported under Windows® 2000.

### 2.15.1 Installing Windows® 2000 / XP / XP 64-bit Without RAID Functions

If you want to install Windows® 2000 / XP / XP 64-bit OS on your SATA / SATAII HDDs without RAID functions, please follow below steps.

#### Using SATA / SATAII HDDs with NCQ function

##### STEP 1: Set Up BIOS.

- A. Enter BIOS SETUP UTILITY →Advanced screen →IDE Configuration.
- B. Set “SATAII Configuration” to [Enhanced], and then in the option “Configure SATAII as”, please set the option to [AHCI].

##### STEP 2: Make a SATA / SATAII driver diskette.

- A. Insert the Support CD into your optical drive to boot your system.
- B. During POST at the beginning of system boot-up, press <F11> key, and then a window for boot devices selection appears. Please select CD-ROM as the boot device.
- C. When you see the message on the screen, “Do you want to generate Serial ATA driver diskette [Y/N]?”, press <Y>.
- D. Then you will see these messages,

**Please insert a diskette into the floppy drive.**

**WARNING! Formatting the floppy diskette will lose ALL data in it!**

**Start to format and copy files [Y/N]?**

Please insert a floppy diskette into the floppy drive, and press <Y>.

- E. The system will start to format the floppy diskette and copy SATA / SATAII drivers into the floppy diskette.

---

**STEP 3: Install Windows® XP / XP 64-bit OS on your system. (Windows® 2000 is not supported.)**

After making a SATA / SATAII driver diskette, you can start to install Windows® XP / XP 64-bit on your system. At the beginning of Windows® setup, press F6 to install a third-party AHCI driver. When prompted, insert the SATA / SATAII driver diskette containing the Intel® AHCI driver. After reading the floppy disk, the driver will be presented. Select the driver to install according to the mode you choose and the OS you install. You may select: "Intel(R) ICH10 SATAAHCI Controller (Desktop - Windows XP)" for Windows® XP or "Intel(R) ICH10 SATAAHCI Controller (Desktop - Windows XP64)" for Windows® XP 64-bit.

**Using SATA / SATAII HDDs without NCQ function**

**STEP 1: Set up BIOS.**

- A. Enter BIOS SETUP UTILITY → Advanced screen → IDE Configuration.
- B. Set "SATAII Configuration" to [Enhanced], and then in the option "Configure SATAII as", please set the option to [IDE].

**STEP 2: Install Windows® 2000 / XP / XP 64-bit OS on your system.**

### **2.15.2 Installing Windows® Vista™ / Vista™ 64-bit Without RAID Functions**

If you want to install Windows® Vista™ / Vista™ 64-bit OS on your SATA / SATAII HDDs without RAID functions, please follow below steps.

**Using SATA / SATAII HDDs with NCQ function**

**STEP 1: Set Up BIOS.**

- A. Enter BIOS SETUP UTILITY → Advanced screen → IDE Configuration.
- B. Set "SATAII Configuration" to [Enhanced], and then in the option "Configure SATAII as", please set the option to [AHCI].

**STEP 2: Install Windows® Vista™ / Vista™ 64-bit OS on your system.**

Insert the Windows® Vista™ / Vista™ 64-bit optical disk into the optical drive to boot your system, and follow the instruction to install Windows® Vista™ / Vista™ 64-bit OS on your system. When you see "Where do you want to install Windows?" page, please insert the ASRock Support CD into your optical drive, and click the "Load Driver" button on the left on the bottom to load the Intel® AHCI drivers. Intel® AHCI drivers are in the following path in our Support CD:

.. \ **I386** (For Windows® Vista™ OS)

.. \ **AMD64** (For Windows® Vista™ 64-bit OS)

After that, please insert Windows® Vista™ / Vista™ 64-bit optical disk into the optical drive again to continue the installation.



---

### Using SATA / SATAII HDDs without NCQ function

#### STEP 1: Set up BIOS.

- A. Enter BIOS SETUP UTILITY → Advanced screen → IDE Configuration.
- B. Set "SATAII Configuration" to [Enhanced], and then in the option "Configure SATAII as", please set the option to [IDE].

#### STEP 2: Install Windows® Vista™ / Vista™ 64-bit OS on your system.

### 2.16 Untied Overclocking Technology

This motherboard supports Untied Overclocking Technology, which means during overclocking, FSB enjoys better margin due to fixed PCI / PCIE buses. Before you enable Untied Overclocking function, please enter "Overclock Mode" option of BIOS setup to set the selection from [Auto] to [Manual]. Therefore, CPU FSB is untied during overclocking, but PCI / PCIE buses are in the fixed mode so that FSB can operate under a more stable overclocking environment.



Please refer to the warning on page 8 for the possible overclocking risk before you apply Untied Overclocking Technology.

---

## Chapter 3: BIOS SETUP UTILITY

### 3.1 Introduction

This section explains how to use the BIOS SETUP UTILITY to configure your system. The BIOS FWH chip on the motherboard stores the BIOS SETUP UTILITY. You may run the BIOS SETUP UTILITY when you start up the computer. Please press <F2> during the Power-On-Self-Test (POST) to enter the BIOS SETUP UTILITY, otherwise, POST will continue with its test routines.

If you wish to enter the BIOS SETUP UTILITY after POST, restart the system by pressing <Ctl> + <Alt> + <Delete>, or by pressing the reset button on the system chassis. You may also restart by turning the system off and then back on.



Because the BIOS software is constantly being updated, the following BIOS setup screens and descriptions are for reference purpose only, and they may not exactly match what you see on your screen.

#### 3.1.1 BIOS Menu Bar

The top of the screen has a menu bar with the following selections:

- Main** To set up the system time/date information
- Advanced** To set up the advanced BIOS features
- H/W Monitor** To display current hardware status
- Boot** To set up the default system device to locate and load the Operating System
- Security** To set up the security features
- Exit** To exit the current screen or the BIOS SETUP UTILITY

Use <←> key or <→> key to choose among the selections on the menu bar, and then press <Enter> to get into the sub screen.

### 3.1.2 Navigation Keys

Please check the following table for the function description of each navigation key.

Navigation Key(s)	Function Description
/	Moves cursor left or right to select Screens
← / →	Moves cursor up or down to select items
↑ / ↓	To change option for the selected items
<Enter>	To bring up the selected screen
<F1>	To display the General Help Screen
<F9>	To load optimal default values for all the settings
<F10>	To save changes and exit the BIOS SETUP UTILITY
<ESC>	To jump to the Exit Screen or exit the current screen

### 3.2 Main Screen

When you enter the BIOS SETUP UTILITY, the Main screen will appear and display the system overview.

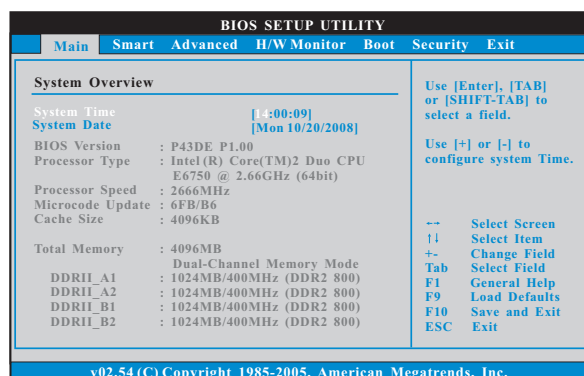

#### System Time [Hour:Minute:Second]

Use this item to specify the system time.

#### System Date [Day Month/Date/Year]

Use this item to specify the system date.

### 3.3 Smart Screen

In the Smart screen, you can load the BIOS setup according to your requirements.

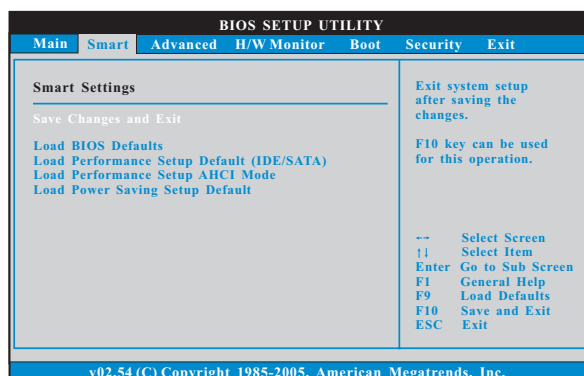

#### Save Changes and Exit

When you select this option, it will pop-out the following message, "Save configuration changes and exit setup?" Select [OK] to save the changes and exit the BIOS SETUP UTILITY.

#### Load BIOS Defaults

Load BIOS default values for all the setup questions. F9 key can be used for this operation.

#### Load Performance Setup Default (IDE/SATA)

This performance setup default may not be compatible with all system configurations. If system boot failure occurs after loading, please resume optimal default settings. F5 key can be used for this operation.

#### Load Performance Setup AHCI Mode

This performance setup AHCI mode may not be compatible with all system configurations. If system boot failure occurs after loading, please resume optimal default settings. F3 key can be used for this operation.

#### Load Power Saving Setup Default

Load power saving setup default. F6 key can be used for this operation.

### 3.4 Advanced Screen

In this section, you may set the configurations for the following items: Overclock Configuration, CPU Configuration, Chipset Configuration, ACPI Configuration, IDE Configuration, PCIPnP Configuration, Floppy Configuration, SuperIO Configuration, and USB Configuration.

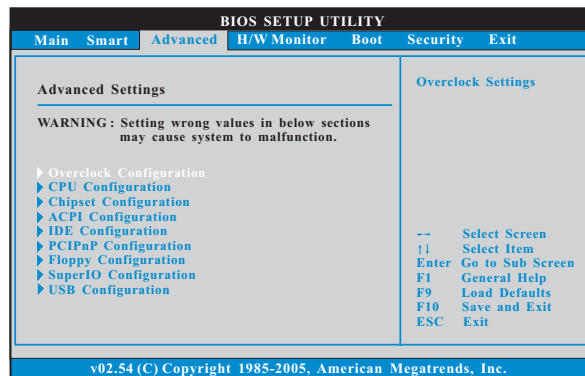

Setting wrong values in this section may cause the system to malfunction.

#### 3.4.1 Overclock Configuration

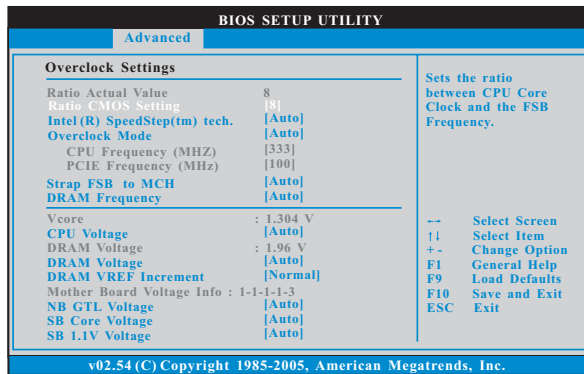

##### Ratio Actual Value

This is a read-only item, which displays the ratio actual value of this motherboard.

### Ratio CMOS Setting

If the ratio status is unlocked, you will find this item appear to allow you changing the ratio value of this motherboard.

### Intel (R) SpeedStep(tm) tech.

Intel (R) SpeedStep(tm) tech. is Intel's new power saving technology. Processor can switch between multiple frequency and voltage points to enable power savings. The default value is [Auto]. Configuration options: [Auto], [Enabled] and [Disabled]. If you install Windows® XP and select [Auto], you need to set the "Power Schemes" as "Portable/Laptop" to enable this function. If you install Windows® Vista™ and want to enable this function, please set this item to [Enabled]. This item will be hidden if the current CPU does not support Intel (R) SpeedStep(tm) tech..



Please note that enabling this function may reduce CPU voltage and lead to system stability or compatibility issue with some power supplies. Please set this item to [Disable] if above issue occurs.

### Overclock Mode

Use this to select Overclock Mode. Configuration options: [Auto], [Manual], [I.O.T.] and [Optimized]. The default value is [Auto]. If you select [Manual], Untied Overclocking function is enabled. Please refer to page 33 for the details of Untied Overclocking Technology. Therefore, you are allowed to adjust the CPU frequency and PCIE frequency in the following two items. If you select [I.O.T.] (Intelligent Overclocking Technology), the system will automatically enable the overclocking function when your CPU is heavy loaded.

### CPU Frequency (MHz)

Use this option to adjust CPU frequency.

### PCIE Frequency (MHz)

Use this option to adjust PCIE frequency.

### Strap FSB to MCH

Use this item to strap FSB to MCH. Configuration options: [Auto], [200], [266], [333] and [400].

### DRAM Frequency

If [Auto] is selected, the motherboard will detect the memory module(s) inserted and assigns appropriate frequency automatically. You may select [333MHz (DDR2 667)], [400MHz (DDR2 800)], [533MHz (DDR2 1066)] or [600MHz (DDR2 1200)]. The configuration options depend on the CPU and memory module you adopt on this motherboard. Please refer to page 8 for the CPU FSB frequency and its corresponding memory support frequency.

---

**Vcore : 1.304 V**

**CPU Voltage**

Use this to select CPU Voltage. Configuration options: [Auto] and [Manual].  
The default value of this feature is [Auto].

**DRAM Voltage : 1.96 V**

**DRAM Voltage**

Use this to select DRAM Voltage. Configuration options: [Auto], [1.79V], [1.85V], [1.90V], [1.96V], [2.02V], [2.08V], [2.14V], [2.20V], [2.31V], [2.37V], [2.42V], [2.48V], [2.54V], [2.60V], [2.66V] and [2.72V]. The default value of this feature is [Auto].

**DRAM VREF Increment**

Use this to select DRAM VREF Increment. The default value of this feature is [Normal]. Configuration options: [Normal], [+20 mV], [+40 mV], [+60 mV], [+80 mV] and [+100 mV].

**Mother Board Voltage Info : 1-1-1-1-3**

**NB GTL Voltage**

Use this to select NB GTL Voltage. Configuration options: [Auto], [Normal] and [Low]. The default value of this feature is [Auto].

**SB Core Voltage**

Use this to select SB Core Voltage. Configuration options: [Auto], [Low], [Middle], [High] and [Highest]. The default value of this feature is [Auto].

**SB 1.1V Voltage**

Use this to select SB 1.1V Voltage. Configuration options: [Auto], [Low], [Middle], [High] and [Highest]. The default value of this feature is [Auto].

**GLTREF Voltage**

Use this to select GLTREF Voltage. Configuration options: [Auto], [0.67 x Vtt], [0.65 x Vtt], [0.63 x Vtt] and [0.615 x Vtt]. The default value of this feature is [Auto].

**Mother Board Voltage Info : 1.12-1.20-1.50**

**NB 1.1V Voltage**

Use this to select NB 1.1V Voltage. The default value of this feature is [Auto].  
Standard: 1.12V. Max: 2.22V. Increment: 0.02V.

**VTT Voltage**

Use this to select VTT Voltage. Configuration options: [Auto], [Low], [Middle], [High] and [Highest]. The default value of this feature is [Auto].

**PLL Voltage**

Use this to select PLL Voltage. Configuration options: [Auto], [Low], [Middle], [High] and [Highest]. The default value of this feature is [Auto].

### 3.4.2 CPU Configuration

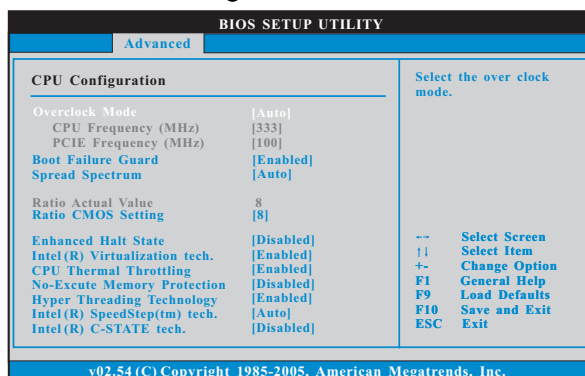

#### Overclock Mode

Use this to select Overclock Mode. Configuration options: [Auto], [Manual], [I.O.T.] and [Optimized]. The default value is [Auto]. If you select [Manual], Untied Overclocking function is enabled. Please refer to page 33 for the details of Untied Overclocking Technology. Therefore, you are allowed to adjust the CPU frequency and PCIE frequency in the following two items. If you select [I.O.T.] (Intelligent Overclocking Technology), the system will automatically enable the overlocking function when your CPU is heavy loaded.

#### CPU Frequency (MHz)

Use this option to adjust CPU frequency.

#### PCIE Frequency (MHz)

Use this option to adjust PCIE frequency.

#### Boot Failure Guard

Enable or disable the feature of Boot Failure Guard.

#### Spread Spectrum

This item should always be [Auto] for better system stability.

#### Ratio Actual Value

This is a read-only item, which displays the ratio actual value of this motherboard.

#### Ratio CMOS Setting

If the ratio status is unlocked, you will find this item appear to allow you changing the ratio value of this motherboard.

#### Enhance Halt State

All processors support the Halt State (C1). The C1 state is supported through the native processor instructions HLT and MWAIT and requires no hardware support from the chipset. In the C1 power state, the processor maintains the context of the system caches.



---

**Intel (R) Virtualization tech.**

When this option is set to [Enabled], a VMM (Virtual Machine Architecture) can utilize the additional hardware capabilities provided by Vanderpool Technology. This option will be hidden if the installed CPU does not support Intel (R) Virtualization Technology.

**CPU Thermal Throttling**

You may select [Enabled] to enable P4 CPU internal thermal control mechanism to keep the CPU from overheated.

**No-Execute Memory Protection**

No-Execution (NX) Memory Protection Technology is an enhancement to the IA-32 Intel Architecture. An IA-32 processor with "No Execute (NX) Memory Protection" can prevent data pages from being used by malicious software to execute code. This option will be hidden if the current CPU does not support No-Execute Memory Protection.

**Hyper Threading Technology**

To enable this feature, it requires a computer system with an Intel Pentium® 4 processor that supports Hyper-Threading technology and an operating system that includes optimization for this technology, such as Microsoft® Windows® XP or Vista™. Set to [Enabled] if using Microsoft® Windows® XP, Vista™, or Linux kernel version 2.4.18 or higher. This option will be hidden if the installed CPU does not support Hyper-Threading technology.

**Intel (R) SpeedStep(tm) tech.**

Intel (R) SpeedStep(tm) tech. is Intel's new power saving technology. Processor can switch between multiple frequency and voltage points to enable power savings. The default value is [Auto]. Configuration options: [Auto], [Enabled] and [Disabled]. If you install Windows® XP and select [Auto], you need to set the "Power Schemes" as "Portable/Laptop" to enable this function. If you install Windows® Vista™ and want to enable this function, please set this item to [Enabled]. This item will be hidden if the current CPU does not support Intel (R) SpeedStep(tm) tech..



Please note that enabling this function may reduce CPU voltage and lead to system stability or compatibility issue with some power supplies. Please set this item to [Disable] if above issue occurs.

**Intel (R) C-STATE tech.**

Intel (R) C-STATE tech. is achieved by making the power and thermal control unit part of the core logic and not part of the chipset as before. Migration of the power and thermal management flow into the processor allows us to use a hardware coordination mechanism in which each core can request any C-state it wishes, thus allowing for individual core savings to be maximized. The CPU C-state is determined and entered based on the lowest common denominator of both cores' requests, portraying a single CPU entity to the chipset power

management hardware and flows. Thus, software can manage each core independently, while the actual power management adheres to the platform and CPU shared resource restrictions. Configuration options are: [C2], [C3], [C4] and [Disabled]. The default value is [Disabled].

### 3.4.3 Chipset Configuration

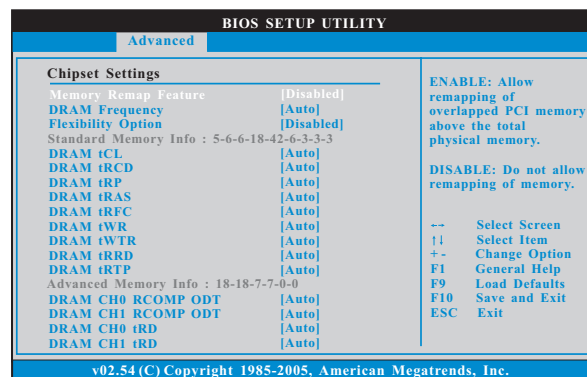

#### Memory Remap Feature

Use this item to enable or disable memory remap feature. Configuration options: [Enabled] and [Disabled]. The default value is [Disabled].

#### DRAM Frequency

If [Auto] is selected, the motherboard will detect the memory module(s) inserted and assigns appropriate frequency automatically. You may select [333MHz (DDR2 667)], [400MHz (DDR2 800)], [533MHz (DDR2 1066)] or [600MHz (DDR2 1200)]. The configuration options depend on the CPU and memory module you adopt on this motherboard. Please refer to page 8 for the CPU FSB frequency and its corresponding memory support frequency.

#### Flexibility Option

The default value of this option is [Disabled]. It will allow better tolerance for memory compatibility when it is set to [Enabled].

#### Standard Memory Info : 5-6-6-18-42-6-3-3-3

#### DRAM tCL

Use this item to adjust the means of memory accessing. Configuration options : [3], [4], [5], [6], [7] and [Auto].

#### DRAM tRAS

This controls the number of DRAM clocks for TRAS. Configuration options: Configuration options: [Auto], [9] to [24].

#### DRAM tRP

This controls the number of DRAM clocks for TRP. Configuration options: Configuration options: [Auto], [3] to [10].

---

**DRAM tRCD**

This controls the number of DRAM clocks for TRCD. Configuration options:  
Configuration options: [Auto], [3] to [10].

**DRAM tWR**

This controls the number of DRAM clocks for TWR. Configuration options:  
Configuration options: [Auto], [3] to [15].

**DRAM tRFC**

This controls the number of DRAM clocks for TRFC. Configuration options:  
Configuration options: [Auto], [15] to [78].

**DRAM tWTR**

This controls the number of DRAM clocks for TWTR. Configuration options:  
Configuration options: [Auto], [2] to [15].

**DRAM tRRD**

This controls the number of DRAM clocks for TRRD. Configuration options:  
Configuration options: [Auto], [2] to [15].

**DRAM tRTP**

This controls the number of DRAM clocks for TRTP. Configuration options:  
Configuration options: [Auto], [2] to [15].

**Advanced Memory Info : 18-18-7-7-0-0****DRAM CH0 RCOMP ODT**

This controls the number of DRAM clocks for CH0 RCOMP ODT.  
Configuration options: Configuration options: [Auto], [1] to [63].

**DRAM CH1 RCOMP ODT**

This controls the number of DRAM clocks for CH1 RCOMP ODT.  
Configuration options: Configuration options: [Auto], [1] to [63].

**DRAM CH0 tRD**

This controls the number of DRAM clocks for CH0 TRD. Configuration options:  
Configuration options: [Auto], [0] to [30].

**DRAM CH1 tRD**

This controls the number of DRAM clocks for CH1 TRD. Configuration options:  
Configuration options: [Auto], [0] to [30].

**DRAM CH0 tRD Phase Adjust**

This controls the number of DRAM clocks for CH0 TRD Phase Adjust.  
Configuration options: Configuration options: [Auto], [0] to [62].

**DRAM CH1 tRD Phase Adjust**

This controls the number of DRAM clocks for CH1 TRD Phase Adjust.  
Configuration options: Configuration options: [Auto], [0] to [62].

**Intelligent Energy Saver**

Intelligent Energy Saver is a revolutionary technology that delivers unparalleled power savings. The default value is [Disabled]. Configuration options: [Enabled] and [Disabled]. If you want to enable this function,

please set this item to [Enabled]. Besides the BIOS option, you can also choose our Intelligent Energy Saver utility to enable this function.

**Primary Graphics Adapter**

This allows you to select [PCI] or [PCI Express] as the boot graphic adapter priority. The default value is [PCI].

**OnBoard HD Audio**

Select [Auto], [Enabled] or [Disabled] for the onboard HD Audio feature. If you select [Auto], the onboard HD Audio will be disabled when PCI Sound Card is plugged.

**Front Panel**

Select [Auto], [Enabled] or [Disabled] for the onboard HD Audio Front Panel.

**CD-In**

Use this item to enable or disable CD-In of OnBoard HD Audio. If you plan to use this motherboard to submit Windows® Vista™ logo test, please disable this option.

**OnBoard Lan**

This allows you to enable or disable the "OnBoard Lan feature.

**OnBoard IDE**

This allows you to enable or disable the "OnBoard IDE" feature.

**CIR10 Field 1**

Use this to enable or disable CIR10 Field 1. The default value of this feature is [Enabled].

### 3.4.4 ACPI Configuration

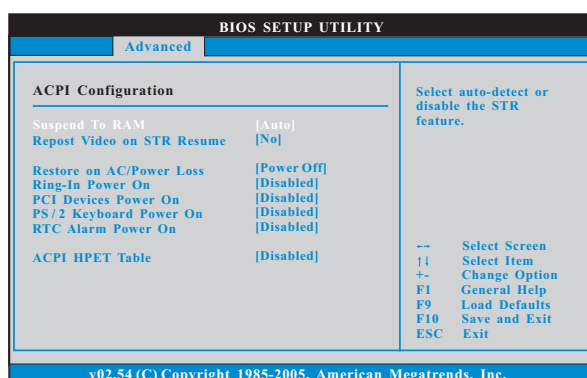

#### Suspend to RAM

Use this item to select whether to auto-detect or disable the Suspend-to-RAM feature. Select [Auto] will enable this feature if the OS supports it. If you set this item to [Disabled], the function "Repost Video on STR Resume" will be hidden.

#### Repost Video on STR Resume

This feature allows you to repost video on STR resume. (STR refers to suspend to RAM.)

#### Restore on AC/Power Loss

This allows you to set the power state after an unexpected AC/power loss. If [Power Off] is selected, the AC/power remains off when the power recovers. If [Power On] is selected, the AC/power resumes and the system starts to boot up when the power recovers.

#### Ring-In Power On

Use this item to enable or disable Ring-In signals to turn on the system from the power-soft-off mode.

#### PCI Devices Power On

Use this item to enable or disable PCI devices to turn on the system from the power-soft-off mode.

#### PS/2 Keyboard Power On

Use this item to enable or disable PS/2 keyboard to turn on the system from the power-soft-off mode.

#### RTC Alarm Power On

Use this item to enable or disable RTC (Real Time Clock) to power on the system.

### ACPI HPET Table

Use this item to enable or disable ACPI HPET Table. The default value is [Disabled]. Please set this option to [Enabled] if you plan to use this motherboard to submit Windows® Vista™ certification.

## 3.4.5 IDE Configuration

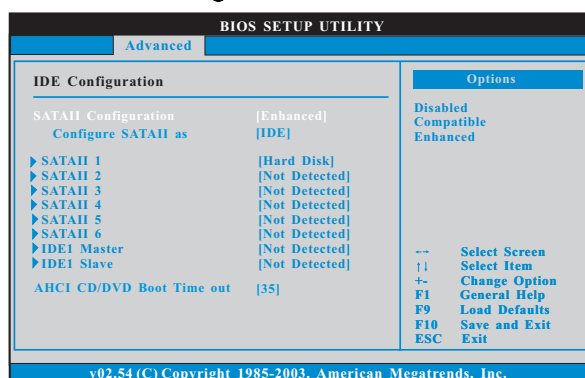

### SATAII Configuration

Please select [**Compatible**] when you install legacy OS. If native OS (Windows 2000 / XP) is installed, please select [**Enhanced**]. Then in the option “Configure SATAII as”, you are allowed to set the selection to [IDE] or [AHCI]. The default value is [IDE].

If you select [AHCI] mode, the option “Hot Plug” will appear. You are allowed to use the Hot Plug function under Windows environment if this option is enabled. Configuration options: [Enabled] and [Disabled].



AHCI (Advanced Host Controller Interface) supports NCQ and other new features that will improve SATA disk performance but IDE mode does not have these advantages.

### OnBoard IDE Controller

Use this item to enable or disable onboard IDE controller. The default value is [Enabled].

### IDE Device Configuration

You may set the IDE configuration for the device that you specify. We will use the “Primary IDE Master” as the example in the following instruction.

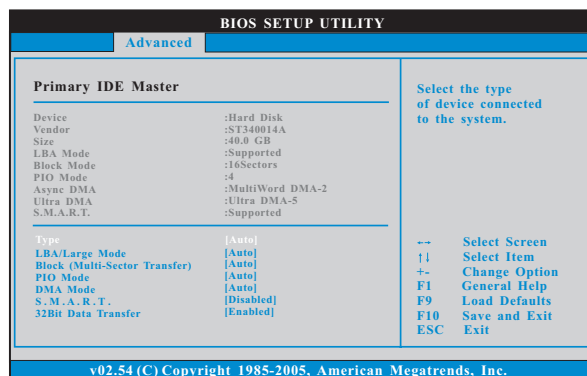

### TYPE

Use this item to configure the type of the IDE device that you specify.

Configuration options: [Not Installed], [Auto], [CD/DVD], and [ARMD].

**[Not Installed]:** Select [Not Installed] to disable the use of IDE device.

**[Auto]:** Select [Auto] to automatically detect the hard disk drive.



After selecting the hard disk information into BIOS, use a disk utility, such as FDISK, to partition and format the new IDE hard disk drives. This is necessary so that you can write or read data from the hard disk. Make sure to set the partition of the Primary IDE hard disk drives to active.

**[CD/DVD]:** This is used for IDE CD/DVD drives.

**[ARMD]:** This is used for IDE ARMD (ATAPI Removable Media Device), such as MO.

### LBA/Large Mode

Use this item to select the LBA/Large mode for a hard disk > 512 MB under DOS and Windows; for Netware and UNIX user, select [Disabled] to disable the LBA/Large mode.

### Block (Multi-Sector Transfer)

The default value of this item is [Auto]. If this feature is enabled, it will enhance hard disk performance by reading or writing more data during each transfer.

### PIO Mode

Use this item to set the PIO mode to enhance hard disk performance by optimizing the hard disk timing.

### DMA Mode

DMA capability allows the improved transfer-speed and data-integrity for compatible IDE devices.

### S.M.A.R.T.

Use this item to enable or disable the S.M.A.R.T. (Self-Monitoring, Analysis, and Reporting Technology) feature. Configuration options: [Disabled], [Auto], [Enabled].

### 32-Bit Data Transfer

Use this item to enable 32-bit access to maximize the IDE hard disk data transfer rate.

## 3.4.6 PCI/PnP Configuration

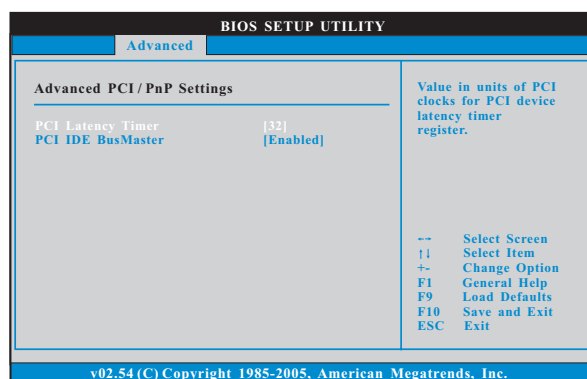

### PCI Latency Timer

The default value is 32. It is recommended to keep the default value unless the installed PCI expansion cards' specifications require other settings.

### PCI IDE BusMaster

Use this item to enable or disable the PCI IDE BusMaster feature.



### 3.4.7 Floppy Configuration

In this section, you may configure the type of your floppy drive.

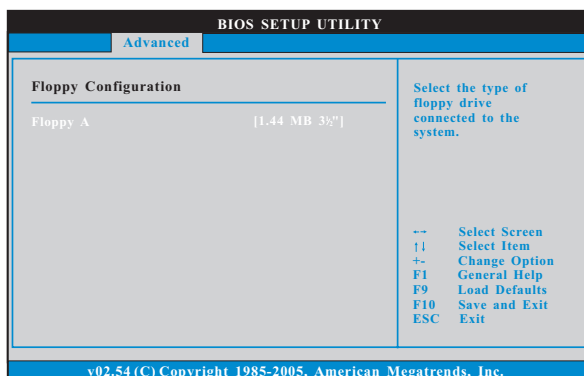

### 3.4.8 Super IO Configuration

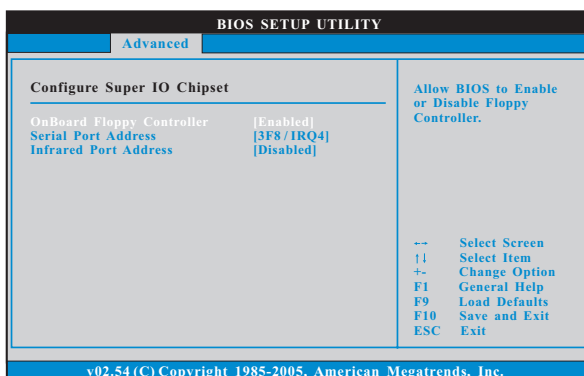

#### OnBoard Floppy Controller

Use this item to enable or disable floppy drive controller.

#### Serial Port Address

Use this item to set the address for the onboard serial port or disable it.

Configuration options: [Disabled], [3F8 / IRQ4], [2F8 / IRQ3], [3E8 / IRQ4], [2E8 / IRQ3].

#### Infrared Port Address

Use this item to set the address for the onboard infrared port or disable it.

Configuration options: [Disabled], [2F8 / IRQ3], and [2E8 / IRQ3].

### 3.4.9 USB Configuration

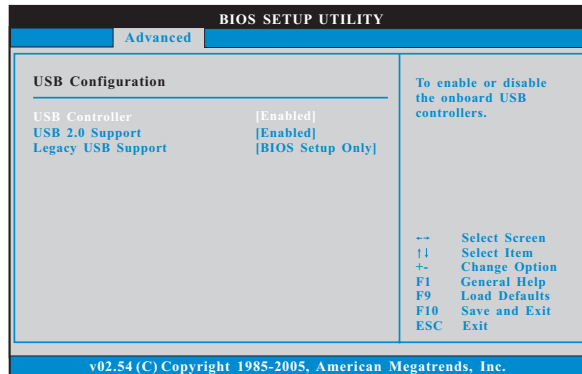

#### USB Controller

Use this item to enable or disable the use of USB controller.

#### USB 2.0 Support

Use this item to enable or disable the USB 2.0 support.

#### Legacy USB Support

Use this option to select legacy support for USB devices. There are four configuration options: [Enabled], [Auto], [Disabled] and [BIOS Setup Only]. The default value is [BIOS Setup Only]. Please refer to below descriptions for the details of these four options:

[Enabled] - Enables support for legacy USB.

[Auto] - Enables legacy support if USB devices are connected.

[Disabled] - USB devices are not allowed to use under legacy OS and BIOS setup when [Disabled] is selected. If you have USB compatibility issue, it is recommended to select [Disabled] to enter OS.

[BIOS Setup Only] - USB devices are allowed to use only under BIOS setup and Windows / Linux OS.

### 3.5 Hardware Health Event Monitoring Screen

In this section, it allows you to monitor the status of the hardware on your system, including the parameters of the CPU temperature, motherboard temperature, CPU fan speed, chassis fan speed, and the critical voltage.

BIOS SETUP UTILITY						
Main	Smart	Advanced	H/W Monitor	Boot	Security	Exit
<b>Hardware Health Event Monitoring</b>				Enable/Disable CPU Quiet Fan Function.		
CPU Temperature	:	37°C / 98°F				
M/B Temperature	:	31°C / 87°F				
CPU Fan Speed	:	3400 RPM				
Chassis Fan Speed	:	N/A				
Vcore	:	1.629V				
+ 3.30V	:	3.306V				
+ 5.00V	:	5.067V				
+ 12.00V	:	11.890V				
CPU Quiet Fan	:	[Disabled]				
				--	Select Screen	
				F1	Select Item	
				F1	General Help	
				F9	Load Defaults	
				F10	Save and Exit	
				ESC	Exit	

#### CPU Quiet Fan

This item allows you to identify the temperature of CPU fan. If you set this option as [Disabled], the CPU fan will operate in full speed. If you set this option as [Enabled], you will find the items "Target CPU Temperature" and "Target Fan Speed" appear to allow you adjusting them. The default value is [Disabled]. You are allowed to enable this function only when you install 4-pin CPU fan.

#### Target CPU Temperature

The target temperature will be between 45°C/113°F and 65°C/149°F. The default value is 50°C/122°F.

#### Target Fan Speed

Use this option to set the target fan speed. You can freely adjust the target fan speed according to the target CPU temperature that you choose. Configuration options: [Level 1], [Level 2], [Level 3], [Level 4], [Level 5], [Level 6] [Level 7], [Level 8] and [Level 9].

### 3.6 Boot Screen

In this section, it will display the available devices on your system for you to configure the boot settings and the boot priority.

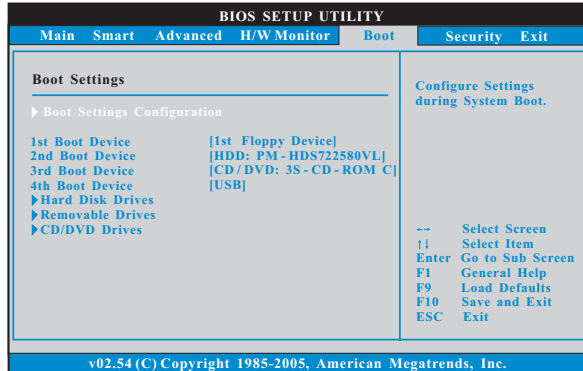

#### 3.6.1 Boot Settings Configuration

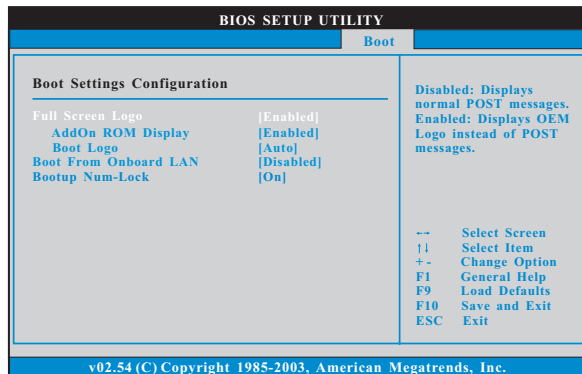

##### Full Screen Logo

Use this item to enable or disable OEM Logo. The default value is [Enabled].

##### AddOn ROM Display

Use this option to adjust AddOn ROM Display. If you enable the option "Full Screen Logo" but you want to see the AddOn ROM information when the system boots, please select [Enabled]. Configuration options: [Enabled] and [Disabled]. The default value is [Enabled].

### Boot Logo

Use this option to select logo in POST screen. This option only appears when you enable the option "Full Screen Logo". Configuration options: [Auto], [PCIe2.0 Revolution], [Scenery] and [ASRock]. The default value is [Auto]. Currently, the option [Auto] is set to Aircraft.

### Boot From Onboard LAN

Use this item to enable or disable the Boot From Onboard LAN feature.

### Boot Up Num-Lock

If this item is set to [On], it will automatically activate the Numeric Lock function after boot-up.

## 3.7 Security Screen

In this section, you may set or change the supervisor/user password for the system. For the user password, you may also clear it.

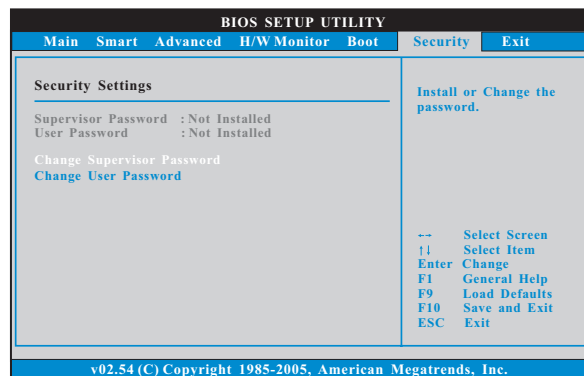

### 3.8 Exit Screen

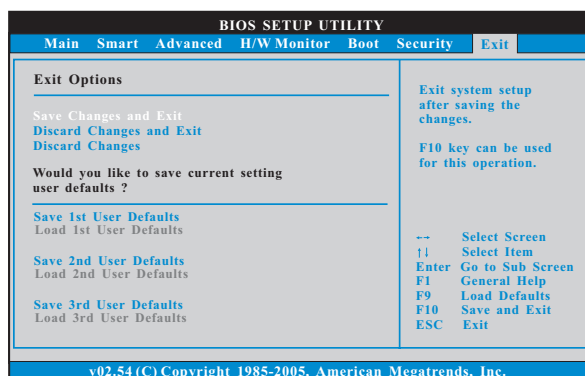

#### Save Changes and Exit

When you select this option, it will pop-out the following message, “Save configuration changes and exit setup?” Select [OK] to save the changes and exit the BIOS SETUP UTILITY.

#### Discard Changes and Exit

When you select this option, it will pop-out the following message, “Discard changes and exit setup?” Select [OK] to exit the BIOS SETUP UTILITY without saving any changes.

#### Discard Changes

When you select this option, it will pop-out the following message, “Discard changes?” Select [OK] to discard all changes.

#### Would you like to save current setting user defaults?

In this option, you are allowed to load and save three user defaults according to your own requirements.

---

## **Chapter 4: Software Support**

### **4.1 Install Operating System**

This motherboard supports various Microsoft® Windows® operating systems: 2000 / XP / XP 64-bit / Vista™ / Vista™ 64-bit. Because motherboard settings and hardware options vary, use the setup procedures in this chapter for general reference only. Refer to your OS documentation for more information.

### **4.2 Support CD Information**

The Support CD that came with the motherboard contains necessary drivers and useful utilities that enhance the motherboard features.

#### **4.2.1 Running The Support CD**

To begin using the support CD, insert the CD into your CD-ROM drive. The CD automatically displays the Main Menu if "AUTORUN" is enabled in your computer. If the Main Menu did not appear automatically, locate and double click on the file "ASSETUP.EXE" from the BIN folder in the Support CD to display the menus.

#### **4.2.2 Drivers Menu**

The Drivers Menu shows the available devices drivers if the system detects installed devices. Please install the necessary drivers to activate the devices.

#### **4.2.3 Utilities Menu**

The Utilities Menu shows the applications software that the motherboard supports. Click on a specific item then follow the installation wizard to install it.

#### **4.2.4 Contact Information**

If you need to contact ASRock or want to know more about ASRock, welcome to visit ASRock's website at <http://www.asrock.com>; or you may contact your dealer for further information.