

ASRock®



N3700-ITX
N3150-ITX

User Manual

Version 1.1

Published May 2015

Copyright©2015 ASRock INC. All rights reserved.

Copyright Notice:

No part of this documentation may be reproduced, transcribed, transmitted, or translated in any language, in any form or by any means, except duplication of documentation by the purchaser for backup purpose, without written consent of ASRock Inc.

Products and corporate names appearing in this documentation may or may not be registered trademarks or copyrights of their respective companies, and are used only for identification or explanation and to the owners' benefit, without intent to infringe.

Disclaimer:

Specifications and information contained in this documentation are furnished for informational use only and subject to change without notice, and should not be constructed as a commitment by ASRock. ASRock assumes no responsibility for any errors or omissions that may appear in this documentation.

With respect to the contents of this documentation, ASRock does not provide warranty of any kind, either expressed or implied, including but not limited to the implied warranties or conditions of merchantability or fitness for a particular purpose.

In no event shall ASRock, its directors, officers, employees, or agents be liable for any indirect, special, incidental, or consequential damages (including damages for loss of profits, loss of business, loss of data, interruption of business and the like), even if ASRock has been advised of the possibility of such damages arising from any defect or error in the documentation or product.



This device complies with Part 15 of the FCC Rules. Operation is subject to the following two conditions:

- (1) this device may not cause harmful interference, and
- (2) this device must accept any interference received, including interference that may cause undesired operation.

CALIFORNIA, USA ONLY

The Lithium battery adopted on this motherboard contains Perchlorate, a toxic substance controlled in Perchlorate Best Management Practices (BMP) regulations passed by the California Legislature. When you discard the Lithium battery in California, USA, please follow the related regulations in advance.

“Perchlorate Material-special handling may apply, see www.dtsc.ca.gov/hazardouswaste/perchlorate”

ASRock Website: <http://www.asrock.com>

The terms HDMI™ and HDMI High-Definition Multimedia Interface, and the HDMI logo are trademarks or registered trademarks of HDMI Licensing LLC in the United States and other countries.



Contents

Chapter 1 Introduction	1
1.1 Package Contents	1
1.2 Specifications	2
1.3 Motherboard Layout	5
1.4 I/O Panel	7
Chapter 2 Installation	9
2.1 Installing Memory Modules (SO-DIMM)	10
2.2 Expansion Slots (PCI Express Slots)	12
2.3 Jumpers Setup	13
2.4 Onboard Headers and Connectors	14
Chapter 3 Software and Utilities Operation	18
3.1 Installing Drivers	18
3.2 ASRock APP Shop	19
3.2.1 UI Overview	19
3.2.2 Apps	20
3.2.3 BIOS & Drivers	23
3.2.4 Setting	24
3.3 Enabling USB Ports for Windows® 7 Installation	25
Chapter 4 UEFI SETUP UTILITY	28
4.1 Introduction	28
4.1.1 UEFI Menu Bar	28
4.1.2 Navigation Keys	29

4.2	Main Screen	30
4.3	Advanced Screen	31
4.3.1	CPU Configuration	32
4.3.2	Chipset Configuration	33
4.3.3	Storage Configuration	35
4.3.4	IntelRMT Configuration	37
4.3.5	Super IO Configuration	38
4.3.6	ACPI Configuration	39
4.3.7	USB Configuration	41
4.3.8	Trusted Computing	42
4.4	Tools	43
4.5	Hardware Health Event Monitoring Screen	45
4.6	Security Screen	46
4.7	Boot Screen	47
4.8	Exit Screen	50

Chapter 1 Introduction

Thank you for purchasing ASRock N3700-ITX / N3150-ITX motherboard, a reliable motherboard produced under ASRock's consistently stringent quality control. It delivers excellent performance with robust design conforming to ASRock's commitment to quality and endurance.

In this manual, Chapter 1 and 2 contains the introduction of the motherboard and step-by-step installation guides. Chapter 3 contains the operation guide of the software and utilities. Chapter 4 contains the configuration guide of the BIOS setup.



Because the motherboard specifications and the BIOS software might be updated, the content of this documentation will be subject to change without notice. In case any modifications of this documentation occur, the updated version will be available on ASRock's website without further notice. If you require technical support related to this motherboard, please visit our website for specific information about the model you are using. You may find the latest VGA cards and CPU support list on ASRock's website as well. ASRock website <http://www.asrock.com>.

1.1 Package Contents

- ASRock N3700-ITX / N3150-ITX Motherboard (Mini-ITX Form Factor)
- ASRock N3700-ITX / N3150-ITX Quick Installation Guide
- ASRock N3700-ITX / N3150-ITX Support CD
- 2 x Serial ATA (SATA) Data Cables (Optional)
- 1 x I/O Panel Shield
- 1 x WiFi Module Screw

1.2 Specifications

- Platform**
- Mini-ITX Form Factor
 - Solid Capacitor design
 - High Density Glass Fabric PCB

- CPU**
- Intel® Quad-Core Pentium® Processor N3700 (up to 2.4 GHz)
(for N3700-ITX)
 - Intel® Quad-Core Processor N3150 (up to 2.08 GHz)
(for N3150-ITX)

- Memory**
- Dual Channel DDR3/DDR3L Memory Technology
 - 2 x DDR3/DDR3L SO-DIMM Slots
 - Supports DDR3/DDR3L 1600/1066 non-ECC, un-buffered memory
 - Max. capacity of system memory: 16GB
(see CAUTION)
- * If only one SO-DIMM module is installed, please install it into DDR3_A1.

- Expansion Slot**
- 1 x PCI Express 2.0 x1 Slot
 - 1 x Half-size Mini-PCI Express Slot

- Graphics**
- Intel® 8th generation (Gen 8) graphics: up to 16 EUs inside
(for N3700-ITX)
 - Intel® 8th generation (Gen 8) graphics: up to 12 EUs inside
(for N3150-ITX)
 - DirectX 11.1, Pixel Shader 5.0
 - Three graphics output options: DVI-D, HDMI and DisplayPort 1.1a
 - Supports Triple Monitor
 - Supports HDMI with max. resolution up to 4K x 2K
(3840x2160) @ 30Hz or 2560x1600 @ 60Hz
 - Supports DVI-D with max. resolution up to 1920x1200 @ 60Hz
 - Supports DisplayPort 1.1a with max. resolution up to 4K x 2K
(3840x2160) @ 30Hz or 2560x1600 @ 60Hz
 - Supports Auto Lip Sync, xvYCC and HBR (High Bit Rate Audio) with HDMI Port (Compliant HDMI monitor is required)
 - Supports HW Accelerated Decoders: H.264 @ level 5.2, H.265/HEVC @ level 5 (GPU accelerated), JPEG, VP8

- Supports HDCP with DVI-D, HDMI and DisplayPort 1.1a Ports
- Supports Full HD 1080p Blu-ray (BD) playback with DVI-D, HDMI and DisplayPort 1.1a Ports

Audio

- 7.1 CH HD Audio with Content Protection (Realtek ALC892 Audio Codec)
- Premium Blu-ray Audio support
- Supports Surge Protection (ASRock Full Spike Protection)
- ELNA Audio Caps

LAN

- PCIE x1 Gigabit LAN 10/100/1000 Mb/s
- Realtek RTL8111GR
- Supports Wake-On-WAN
- Supports Wake-On-LAN
- Supports Lightning/ESD Protection (ASRock Full Spike Protection)
- Supports LAN Cable Detection
- Supports Energy Efficient Ethernet 802.3az
- Supports PXE

Rear Panel I/O

- 1 x PS/2 Mouse/Keyboard Port
- 1 x DVI-D Port
- 1 x HDMI Port
- 1 x DisplayPort 1.1a
- 1 x Optical SPDIF Out Port
- 2 x USB 2.0 Ports (Supports ESD Protection (ASRock Full Spike Protection))
- 4 x USB 3.0 Ports (ASMedia ASM1074 hub) (Supports ESD Protection (ASRock Full Spike Protection))
- 1 x RJ-45 LAN Port with LED (ACT/LINK LED and SPEED LED)
- HD Audio Jacks: Rear Speaker / Central / Bass / Line in / Front Speaker / Microphone

Storage

- 2 x SATA3 6.0 Gb/s Connectors, support NCQ, AHCI and Hot Plug
- 2 x SATA3 6.0 Gb/s Connectors by ASMedia ASM1061, support NCQ, AHCI and Hot Plug

Connector

- 1 x COM Port Header
- 1 x TPM Header

- 1 x CPU Fan Connector (3-pin)
 - 1 x Chassis Fan Connector (3-pin)
 - 1 x 24 pin ATX Power Connector
 - 1 x Front Panel Audio Connector
 - 2 x USB 2.0 Headers (Support 4 USB 2.0 ports) (Supports ESD Protection (ASRock Full Spike Protection))
 - 1 x USB 3.0 Header (Supports 2 USB 3.0 ports) (Supports ESD Protection (ASRock Full Spike Protection))
- * USB3_3_4 is shared with USB_5_6.

BIOS Feature

- 64Mb AMI UEFI Legal BIOS with GUI support
- Supports Plug and Play
- ACPI 1.1 compliant wake up events
- Supports jumperfree
- SMBIOS 2.3.1 support

Hardware Monitor

- CPU/Chassis temperature sensing
- CPU/Chassis Fan Tachometer
- CPU/Chassis Quiet Fan (Auto adjust chassis fan speed by CPU temperature)
- CPU/Chassis Fan multi-speed control
- Voltage monitoring: +12V, +5V, +3.3V, CPU Vcore

OS

- Microsoft® Windows® 10 64-bit / 8.1 64-bit / 7 64-bit
- * To install Windows® 7 64-bit OS, a modified installation disk with xHCI drivers packed into the ISO file is required. Please refer to page 25 for more detailed instructions.
- * For the updated Windows® 10 driver, please visit ASRock's website for details: <http://www.asrock.com>

Certifica- tions

- FCC, CE, WHQL
- ErP/EuP ready (ErP/EuP ready power supply is required)

* For detailed product information, please visit our website: <http://www.asrock.com>



Due to limitation, the actual memory size may be less than 4GB for the reservation for system usage under Windows® 32-bit operating systems. Windows® 64-bit operating systems do not have such limitations. You can use ASRock XFast RAM to utilize the memory that Windows® cannot use.

1.3 Motherboard Layout

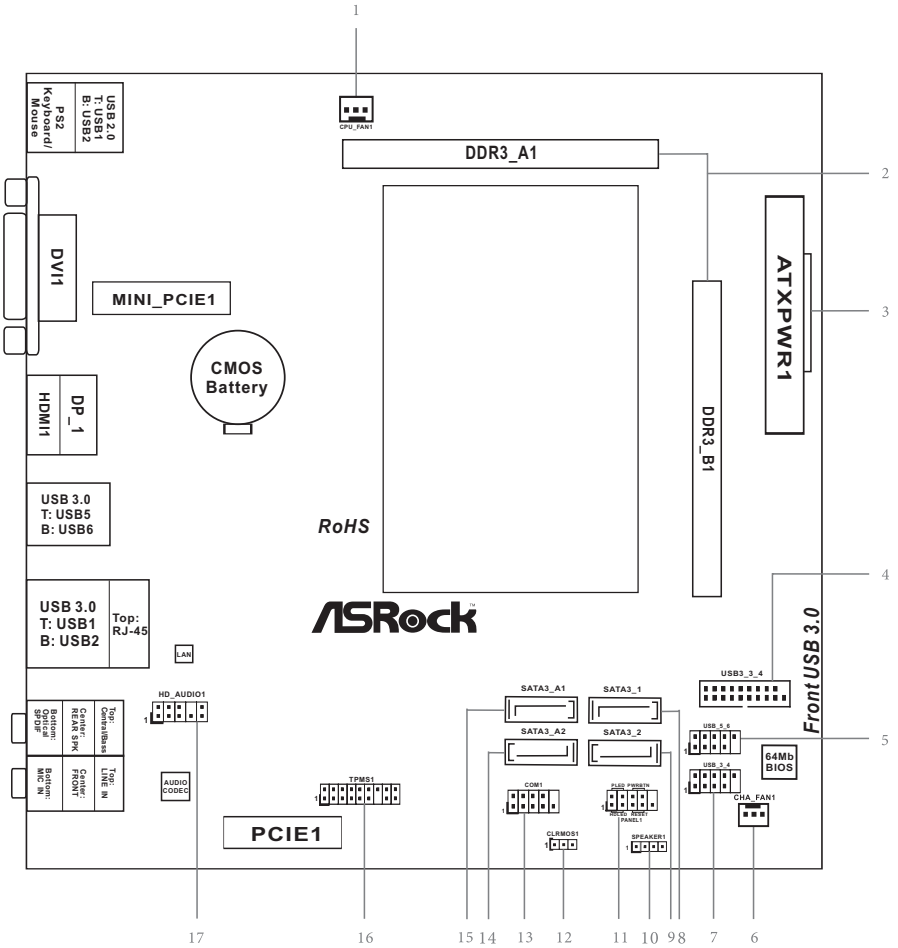

No.	Description
1	CPU Fan Connector (CPU_FAN1)
2	2 x 204-pin DDR3 SO-DIMM Slots (DDR3_A1, DDR3_B1)
3	ATX Power Connector (ATXPWR1)
4	USB 3.0 Header (USB3_3_4)
5	USB 2.0 Header (USB_5_6)
6	Chassis Fan Connector (CHA_FAN1)
7	USB 2.0 Header (USB_3_4)
8	SATA3 Connector (SATA3_1)
9	SATA3 Connector (SATA3_2)
10	Chassis Speaker Header (SPEAKER1)
11	System Panel Header (PANEL1)
12	Clear CMOS Jumper (CLRMOS1)
13	COM Port Header (COM1)
14	SATA3 Connector (SATA3_A2)
15	SATA3 Connector (SATA3_A1)
16	TPM Header (TPMS1)
17	Front Panel Audio Header (HD_AUDIO1)

1.4 I/O Panel

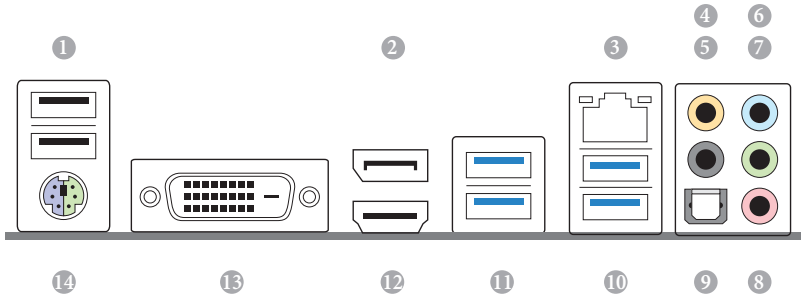

No.	Description	No.	Description
1	USB 2.0 Ports (USB12)	8	Microphone (Pink)
2	DisplayPort 1.1a	9	Optical SPDIF Out Port
3	LAN RJ-45 Port*	10	USB 3.0 Ports (USB3_12)
4	Central / Bass (Orange)	11	USB 3.0 Ports (USB3_56)
5	Rear Speaker (Black)	12	HDMI Port
6	Line In (Light Blue)	13	DVI-D Port
7	Front Speaker (Lime)**	14	PS/2 Mouse/Keyboard Port

* There are two LEDs on each LAN port. Please refer to the table below for the LAN port LED indications.

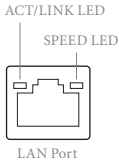

Activity / Link LED		Speed LED	
Status	Description	Status	Description
Off	No Link	Off	10Mbps connection
Blinking	Data Activity	Orange	100Mbps connection
On	Link	Green	1Gbps connection

** If you use a 2-channel speaker, please connect the speaker's plug into "Front Speaker Jack". See the table below for connection details in accordance with the type of speaker you use.

Audio Output Channels	Front Speaker (No. 7)	Rear Speaker (No. 5)	Central / Bass (No. 4)	Line In (No. 6)
2	V	--	--	--
4	V	V	--	--
6	V	V	V	--
8	V	V	V	V



To enable Multi-Streaming, you need to connect a front panel audio cable to the front panel audio header. After restarting your computer, you will find the "Mixer" tool on your system. Please select "Mixer Toolbox" , click "Enable playback multi-streaming", and click "ok". Choose "2CH", "4CH", "6CH", or "8CH" and then you are allowed to select "Realtek HDA Primary output" to use the Rear Speaker, Central/Bass, and Front Speaker, or select "Realtek HDA Audio 2nd output" to use the front panel audio.

Chapter 2 Installation

This is a Mini-ITX form factor motherboard. Before you install the motherboard, study the configuration of your chassis to ensure that the motherboard fits into it.

Pre-installation Precautions

Take note of the following precautions before you install motherboard components or change any motherboard settings.

- Make sure to unplug the power cord before installing or removing the motherboard. Failure to do so may cause physical injuries to you and damages to motherboard components.
- In order to avoid damage from static electricity to the motherboard's components, NEVER place your motherboard directly on a carpet. Also remember to use a grounded wrist strap or touch a safety grounded object before you handle the components.
- Hold components by the edges and do not touch the ICs.
- Whenever you uninstall any components, place them on a grounded anti-static pad or in the bag that comes with the components.
- When placing screws to secure the motherboard to the chassis, please do not over-tighten the screws! Doing so may damage the motherboard.

2.1 Installing Memory Modules (SO-DIMM)

This motherboard provides two 204-pin DDR3/DDR3L (Double Data Rate 3) SO-DIMM slots. If only one SO-DIMM module is installed, please install it into DDR3_A1.



It is not allowed to install a DDR or DDR2 memory module into a DDR3/DDR3L slot; otherwise, this motherboard and SO-DIMM may be damaged.



The SO-DIMM only fits in one correct orientation. It will cause permanent damage to the motherboard and the SO-DIMM if you force the SO-DIMM into the slot at incorrect orientation.

1

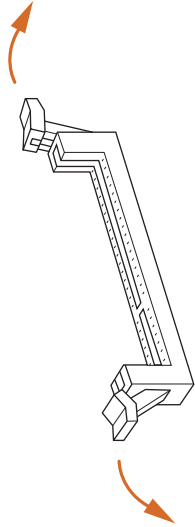

2

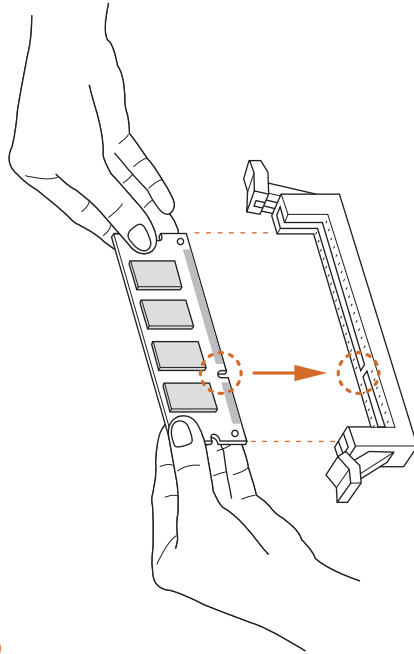

3

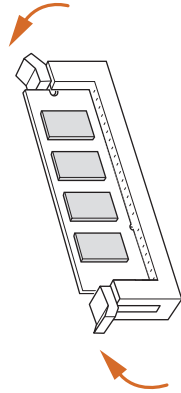

2.2 Expansion Slots (PCI Express Slots)

There is 1 PCI Express slot and 1 mini-PCI Express slot on the motherboard.



Before installing an expansion card, please make sure that the power supply is switched off or the power cord is unplugged. Please read the documentation of the expansion card and make necessary hardware settings for the card before you start the installation.

PCIe slot:

PCIE1 (PCIe 2.0 x1 slot) is used for PCI Express cards with x1 lane width cards.

mini-PCIe slot:

MINI_PCIE1 (mini-PCIe slot) is used for WiFi module.

2.3 Jumpers Setup

The illustration shows how jumpers are setup. When the jumper cap is placed on the pins, the jumper is “Short”. If no jumper cap is placed on the pins, the jumper is “Open”. The illustration shows a 3-pin jumper whose pin1 and pin2 are “Short” when a jumper cap is placed on these 2 pins.

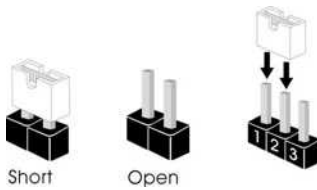

Clear CMOS Jumper
(CLRMO51)
(see p.5, No. 12)

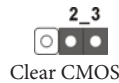

CLRMO51 allows you to clear the data in CMOS. To clear and reset the system parameters to default setup, please turn off the computer and unplug the power cord from the power supply. After waiting for 15 seconds, use a jumper cap to short pin2 and pin3 on CLRMO51 for 5 seconds. However, please do not clear the CMOS right after you update the BIOS. If you need to clear the CMOS when you just finish updating the BIOS, you must boot up the system first, and then shut it down before you do the clear-CMOS action. Please be noted that the password, date, time, and user default profile will be cleared only if the CMOS battery is removed.

2.4 Onboard Headers and Connectors



Onboard headers and connectors are NOT jumpers. Do NOT place jumper caps over these headers and connectors. Placing jumper caps over the headers and connectors will cause permanent damage to the motherboard.

System Panel Header
(9-pin PANEL1)
(see p.5, No. 11)

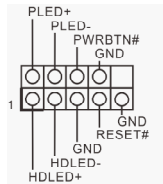

Connect the power switch, reset switch and system status indicator on the chassis to this header according to the pin assignments below. Note the positive and negative pins before connecting the cables.



PWRBTN (Power Switch):

Connect to the power switch on the chassis front panel. You may configure the way to turn off your system using the power switch.

RESET (Reset Switch):

Connect to the reset switch on the chassis front panel. Press the reset switch to restart the computer if the computer freezes and fails to perform a normal restart.

PLED (System Power LED):

Connect to the power status indicator on the chassis front panel. The LED is on when the system is operating. The LED keeps blinking when the system is in S1/S3 sleep state. The LED is off when the system is in S4 sleep state or powered off (S5).

HDLED (Hard Drive Activity LED):

Connect to the hard drive activity LED on the chassis front panel. The LED is on when the hard drive is reading or writing data.

The front panel design may differ by chassis. A front panel module mainly consists of power switch, reset switch, power LED, hard drive activity LED, speaker and etc. When connecting your chassis front panel module to this header, make sure the wire assignments and the pin assignments are matched correctly.

Serial ATA3 Connectors

(SATA3_1:

see p.5, No. 8)

(SATA3_2:

see p.5, No. 9)

(SATA3_A1:

see p.5, No. 15)

(SATA3_A2:

see p.5, No. 14)



These four SATA3

connectors support SATA

data cables for internal

storage devices with up to

6.0 Gb/s data transfer rate.

USB 2.0 Headers

(9-pin USB_3_4)

(see p.5, No. 7)

(9-pin USB_5_6)

(see p.5, No. 5)

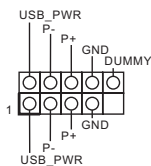

Besides two USB 2.0 ports

on the I/O panel, there

are two headers on this

motherboard. Each USB

2.0 header can support

two ports.

USB 3.0 Header

(19-pin USB3_3_4)

(see p.5, No. 4)

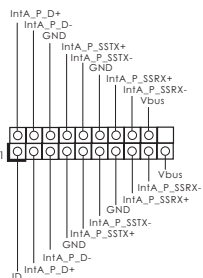

Besides four USB 3.0

ports on the I/O panel,

there is one header on this

motherboard. This USB

3.0 header can support

two ports.

Front Panel Audio Header

(9-pin HD_AUDIO1)

(see p.5, No. 17)

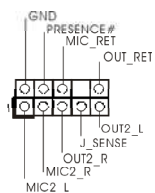

This header is for

connecting audio devices

to the front audio panel.



1. High Definition Audio supports Jack Sensing, but the panel wire on the chassis must support HDA to function correctly. Please follow the instructions in our manual and chassis manual to install your system.
2. If you use an AC'97 audio panel, please install it to the front panel audio header by the steps below:
 - A. Connect Mic_IN (MIC) to MIC2_L.
 - B. Connect Audio_R (RIN) to OUT2_R and Audio_L (LIN) to OUT2_L.
 - C. Connect Ground (GND) to Ground (GND).
 - D. MIC_RET and OUT_RET are for the HD audio panel only. You don't need to connect them for the AC'97 audio panel.
 - E. To activate the front mic, go to the "FrontMic" Tab in the Realtek Control panel and adjust "Recording Volume".

Chassis Speaker Header
(4-pin SPEAKER1)
(see p.5, No. 10)

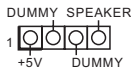

Please connect the chassis speaker to this header.

Chassis Fan Connector
(3-pin CHA_FAN1)
(see p.5, No. 6)



Please connect fan cable to the fan connector and match the black wire to the ground pin.

CPU Fan Connector
(3-pin CPU_FAN1)
(see p.5, No. 1)

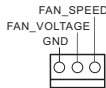

Please connect the CPU fan cable to the connector and match the black wire to the ground pin.

ATX Power Connector
(24-pin ATXPWR1)
(see p.5, No. 3)

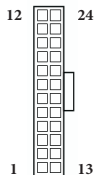

This motherboard provides a 24-pin ATX power connector. To use a 20-pin ATX power supply, please plug it along Pin 1 and Pin 13.

TPM Header
(17-pin TPMS1)
(see p.5, No. 16)

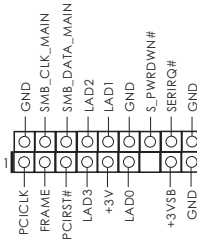

This connector supports Trusted Platform Module (TPM) system, which can securely store keys, digital certificates, passwords, and data. A TPM system also helps enhance network security, protects digital identities, and ensures platform integrity.

Serial Port Header
(9-pin COM1)
(see p.5, No. 13)

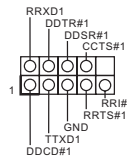

This COM1 header supports a serial port module.

Chapter 3 Software and Utilities Operation

3.1 Installing Drivers

The Support CD that comes with the motherboard contains necessary drivers and useful utilities that enhance the motherboard's features.

Running The Support CD

To begin using the support CD, insert the CD into your CD-ROM drive. The CD automatically displays the Main Menu if "AUTORUN" is enabled in your computer. If the Main Menu does not appear automatically, locate and double click on the file "ASRSETUP.EXE" in the Support CD to display the menu.

Drivers Menu

The drivers compatible to your system will be auto-detected and listed on the support CD driver page. Please click **Install All** or follow the order from top to bottom to install those required drivers. Therefore, the drivers you install can work properly.

Utilities Menu

The Utilities Menu shows the application software that the motherboard supports. Click on a specific item then follow the installation wizard to install it.



*To improve Windows 7 compatibility, please download and install the following hot fix provided by Microsoft.
"KB2720599": <http://support.microsoft.com/kb/2720599/en-us>*

3.2 ASRock APP Shop

The ASRock APP Shop is an online store for purchasing and downloading software applications for your ASRock computer. You can quickly and easily install various apps and support utilities, such as USB Key, XFast LAN, XFast RAM and more. With ASRock APP Shop, you can optimize your system and keep your motherboard up to date simply with a few clicks.

Double-click  on your desktop to access ASRock APP Shop utility.

**You need to be connected to the Internet to download apps from the ASRock APP Shop.*

3.2.1 UI Overview

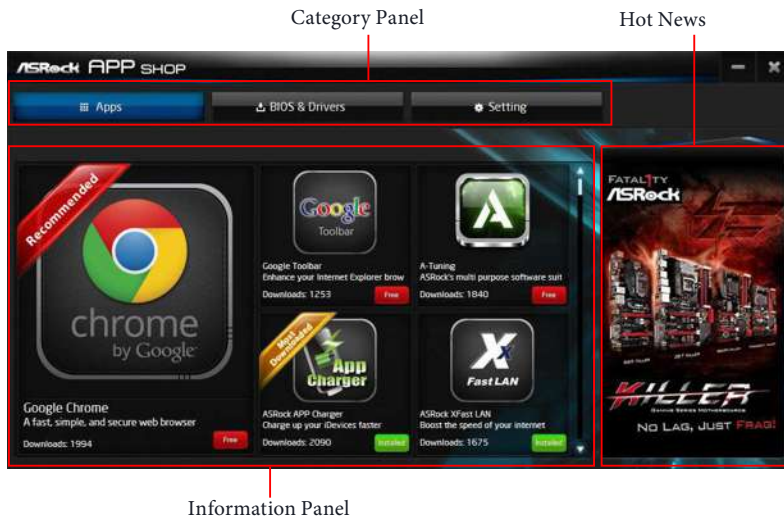

Category Panel: The category panel contains several category tabs or buttons that when selected the information panel below displays the relative information.

Information Panel: The information panel in the center displays data about the currently selected category and allows users to perform job-related tasks.

Hot News: The hot news section displays the various latest news. Click on the image to visit the website of the selected news and know more.

3.2.2 Apps

When the "Apps" tab is selected, you will see all the available apps on screen for you to download.

Installing an App

Step 1

Find the app you want to install.



The most recommended app appears on the left side of the screen. The other various apps are shown on the right. Please scroll up and down to see more apps listed.

You can check the price of the app and whether you have already installed it or not.



- The red icon displays the price or "Free" if the app is free of charge.



- The green "Installed" icon means the app is installed on your computer.

Step 2

Click on the app icon to see more details about the selected app.

Step 3

If you want to install the app, click on the red icon  to start downloading.



Step 4

When installation completes, you can find the green "Installed" icon appears on the upper right corner.



To uninstall it, simply click on the trash can icon .

*The trash icon may not appear for certain apps.

Upgrading an App

You can only upgrade the apps you have already installed. When there is an available new version for your app, you will find the mark of "New Version"  appears below the installed app icon.



Step 1

Click on the app icon to see more details.

Step 2

Click on the yellow icon  to start upgrading.

3.2.3 BIOS & Drivers

Installing BIOS or Drivers

When the "BIOS & Drivers" tab is selected, you will see a list of recommended or critical updates for the BIOS or drivers. Please update them all soon.

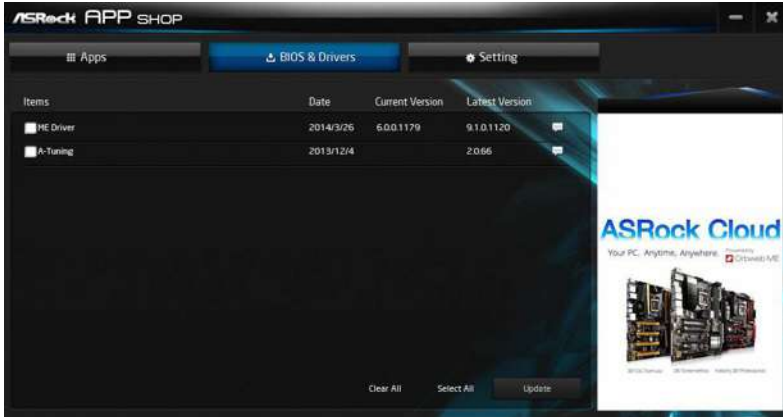

Step 1

Please check the item information before update. Click on  to see more details.

Step 2

Click to select one or more items you want to update.

Step 3

Click Update to start the update process.

3.2.4 Setting

In the "Setting" page, you can change the language, select the server location, and determine if you want to automatically run the ASRock APP Shop on Windows startup.

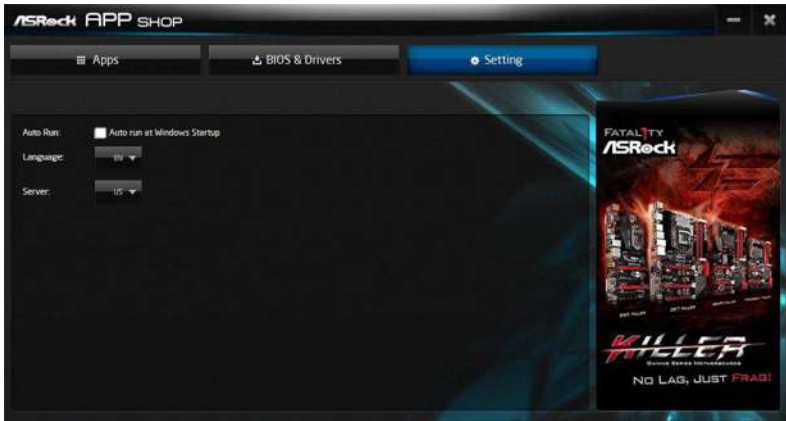

3.3 Enabling USB Ports for Windows® 7 Installation

Intel® Braswell and Skylake has removed their support for the Enhanced Host Controller Interface (EHCI – USB2.0) and only kept the eXtensible Host Controller Interface (XHCI – USB3.0). Due to that fact that XHCI is not included in the Windows 7 inbox drivers, users may find it difficult to install Windows 7 operating system because the USB ports on their motherboard won't work. In order for the USB ports to function properly, please create a Windows® 7 installation disk with the Intel® USB 3.0 eXtensible Host Controller (xHCI) drivers packed into the ISO file.

Requirements

- A Windows® 7 installation disk or USB drive
- USB 3.0 drivers (included in the ASRock Support CD or website)
- A Windows® PC
- Win7 USB Patcher (included in the ASRock Support CD or website)

Scenarios

You have an ODD and PS/2 ports:

If there is an optical disc drive, PS/2 ports and PS/2 Keyboard or mouse on your computer, you can skip the instructions below and go ahead to install Windows® 7 OS.

You only have an ODD (For Intel Skylake platforms only):

If there is an optical disc drive but no PS/2 ports on your computer, please enable the “PS/2 Simulator” option in *UEFI SETUP UTILITY* > *Advanced* > *USB Configuration*, which allows the USB port to function as a PS/2 port, and then you can install the Windows® 7 OS. Please set PS/S Simulator back to disabled after the installation.

You've got nothing:

If you do not have an optical disc drive, please find another computer and follow the instructions below to create a new ISO file with the “Win7 USB Patcher”. Then use the new patched Windows® 7 installation USB drive to install Windows® 7 OS.

Instructions

Step 1

Insert the Windows® 7 installation disk or USB drive to your system.

Step 2

Extract the tool (Win7 USB Patcher) and launch it.

Step 3

Select the “Win7 Folder” from Step1 by clicking the red circle as shown as the picture below.



Step 4

Select the “USB Driver Folder” by clicking the red circle as shown as the picture below.



If you are using ASRock’s Support CD for the USB 3.0 driver, please select your CD-ROM.

Step 5

Select where to save the ISO file by pressing the red circle as shown as the picture below.



Step 6

If you want to burn the patched image to a CD, please check “Burn Image” and select “Target Device to Burn”. If not, the patched ISO image will be exported to the destination selected in Step5. Then Press “Start” to proceed.

Step 7

Now you are able to install Windows® 7 on Braswell or Skylake with the new burned CD. Or please use the patched ISO image to make an OS USB drive to install the OS.

Chapter 4 UEFI SETUP UTILITY

4.1 Introduction

This section explains how to use the UEFI SETUP UTILITY to configure your system. You may run the UEFI SETUP UTILITY by pressing <F2> or right after you power on the computer, otherwise, the Power-On-Self-Test (POST) will continue with its test routines. If you wish to enter the UEFI SETUP UTILITY after POST, restart the system by pressing <Ctl> + <Alt> + <Delete>, or by pressing the reset button on the system chassis. You may also restart by turning the system off and then back on.



Because the UEFI software is constantly being updated, the following UEFI setup screens and descriptions are for reference purpose only, and they may not exactly match what you see on your screen.

4.1.1 UEFI Menu Bar

The top of the screen has a menu bar with the following selections:

Main	For setting system time/date information
Advanced	For advanced system configurations
Tool	Useful tools
H/W Monitor	Displays current hardware status
Security	For security settings
Boot	For configuring boot settings and boot priority
Exit	Exit the current screen or the UEFI Setup Utility

4.1.2 Navigation Keys

Use <←> key or <→> key to choose among the selections on the menu bar, and use <↑> key or <↓> key to move the cursor up or down to select items, then press <Enter> to get into the sub screen. You can also use the mouse to click your required item.

Please check the following table for the descriptions of each navigation key.

Navigation Key(s)	Description
+ / -	To change option for the selected items
<Tab>	Switch to next function
<PGUP>	Go to the previous page
<PGDN>	Go to the next page
<HOME>	Go to the top of the screen
<END>	Go to the bottom of the screen
<F1>	To display the General Help Screen
<F7>	Discard changes and exit the SETUP UTILITY
<F9>	Load optimal default values for all the settings
<F10>	Save changes and exit the SETUP UTILITY
<F12>	Print screen
<ESC>	Jump to the Exit Screen or exit the current screen

4.2 Main Screen

When you enter the UEFI SETUP UTILITY, the Main screen will appear and display the system overview.

N3700-ITX:



N3150-ITX:



4.3 Advanced Screen

In this section, you may set the configurations for the following items:
CPU Configuration, Chipset Configuration, Storage Configuration, IntelRMT Configuration, Super IO Configuration, ACPI Configuration, USB Configuration and Trusted Computing.



Setting wrong values in this section may cause the system to malfunction.

4.3.1 CPU Configuration



Intel SpeedStep Technology

Intel SpeedStep technology allows processors to switch between multiple frequencies and voltage points for better power saving and heat dissipation.

CPU C States Support

Enable CPU C States Support for power saving. It is recommended to keep C1, C6 and C7 all enabled for better power saving.

Enhanced Halt State (C1E)

Enable Enhanced Halt State (C1E) for lower power consumption.

Intel Virtualization Technology

Intel Virtualization Technology allows a platform to run multiple operating systems and applications in independent partitions, so that one computer system can function as multiple virtual systems.

Power Gear

Toggle between three operational modes (Eco, Normal and Sport) to maximize performance or conserve energy.

Eco Mode: Reduces your computer's performance and saves energy.

Normal Mode: Balance performance with power consumption.

Sport Mode: Use more power to achieve the highest performance.

4.3.2 Chipset Configuration



DRAM Voltage

Use this to configure DRAM Voltage. The default value is [Auto].

Primary Graphics Adapter

Select a primary VGA.

Share Memory

Configure the size of memory that is allocated to the integrated graphics processor when the system boots up.

Onboard HD Audio

Enable/disable onboard HD audio. Set to Auto to enable onboard HD audio and automatically disable it when a sound card is installed.

Front Panel

Enable/disable front panel HD audio.

Onboard HDMI HD Audio

Enable audio for the onboard digital outputs.

Onboard LAN

Enable or disable the onboard network interface controller.

PCIe1 Link Speed

Select the link speed for PCIe1.

Deep S5

Configure deep sleep mode for power saving when the computer is shut down.

Restore on AC/Power Loss

Select the power state after a power failure. If [Power Off] is selected, the power will remain off when the power recovers. If [Power On] is selected, the system will start to boot up when the power recovers.

WiFi Radio

Enable or disable the connectivity of the WiFi module.

4.3.3 Storage Configuration



SATA Controller(s)

Enable/disable the SATA controllers.

SATA Mode Selection

AHCI: Supports new features that improve performance.



AHCI (Advanced Host Controller Interface) supports NCQ and other new features that will improve SATA disk performance.

Aggressive Link Power Management

Aggressive Link Power Management allows SATA devices to enter a low power state during periods of inactivity to save power. It is only supported by AHCI mode.

Hard Disk S.M.A.R.T.

S.M.A.R.T stands for Self-Monitoring, Analysis, and Reporting Technology. It is a monitoring system for computer hard disk drives to detect and report on various indicators of reliability.

ASMedia SATA3 Mode

IDE: For better compatibility.

AHCI: Supports new features that improve performance.

4.3.4 IntelRMT Configuration



Intel RMT Support

Enable to load Intel RMT (Ready Mode Technology) SSDT table.

4.3.5 Super IO Configuration



Serial Port 1

Enable or disable the Serial port 1.

Serial Port Address

Select the address of the Serial port.

PS2 Y-Cable

Enable the PS2 Y-Cable or set this option to Auto.

4.3.6 ACPI Configuration



Suspend to RAM

It is recommended to select auto for ACPI S3 power saving.

ACPI HPET Table

Enable the High Precision Event Timer for better performance and to pass WHQL tests.

PS/2 Keyboard Power On

Allow the system to be waked up by a PS/2 Keyboard.

PCIE Device Power On

Allow the system to be waked up by a PCIE device and enable wake on LAN.

Ring-In Power On

Allow the system to be waked up by onboard COM port modem Ring-In signals.

RTC Alarm Power On

Allow the system to be waked up by the real time clock alarm. Set it to By OS to let it be handled by your operating system.

USB Keyboard/Remote Power On

Allow the system to be waked up by an USB keyboard or remote controller.

USB Mouse Power On

Allow the system to be waked up by an USB mouse.

4.3.7 USB Configuration



Legacy USB Support

Enable Legacy USB Support. AUTO option disables legacy support if no USB devices are connected. DISABLE option will keep USB devices available only for EFI applications.

4.3.8 Trusted Computing



Security Device Support

Enable to activate Trusted Platform Module (TPM) security for your hard disk drives.

4.4 Tools



Instant Flash

Save UEFI files in your USB storage device and run Instant Flash to update your UEFI.

Internet Flash

ASRock Internet Flash downloads and updates the latest UEFI firmware version from our servers for you. Please setup network configuration before using Internet Flash.

*For BIOS backup and recovery purpose, it is recommended to plug in your USB pen drive before using this function.

Network Configuration

Use this to configure internet connection settings for Internet Flash.



Internet Setting

Enable or disable sound effects in the setup utility.

UEFI Download Server

Select a server to download the UEFI firmware.

4.5 Hardware Health Event Monitoring Screen

This section allows you to monitor the status of the hardware on your system, including the parameters of the CPU temperature, motherboard temperature, fan speed and voltage.



CPU Fan 1 Setting

This allows you to set CPU fan 1's speed. Configuration options: [Full On] and [Automatic Mode]. The default value is [Full On].

Chassis Fan 1 Setting

This allows you to set chassis fan 1's speed. Configuration options: [Full On], [Automatic Mode] and [Manual]. The default value is [Full On].

4.6 Security Screen

In this section you may set or change the supervisor/user password for the system. You may also clear the user password.



Supervisor Password

Set or change the password for the administrator account. Only the administrator has authority to change the settings in the UEFI Setup Utility. Leave it blank and press enter to remove the password.

User Password

Set or change the password for the user account. Users are unable to change the settings in the UEFI Setup Utility. Leave it blank and press enter to remove the password.

Secure Boot

Enable to support Windows 8.1 Secure Boot.

4.7 Boot Screen

This section displays the available devices on your system for you to configure the boot settings and the boot priority.



Fast Boot

Fast Boot minimizes your computer's boot time. In fast mode you may not boot from an USB storage device. Ultra Fast mode is only supported by Windows 8.1 and the VBIOS must support UEFI GOP if you are using an external graphics card. Please notice that Ultra Fast mode will boot so fast that the only way to enter this UEFI Setup Utility is to Clear CMOS or run the Restart to UEFI utility in Windows.

Boot From Onboard LAN

Allow the system to be waked up by the onboard LAN.

Setup Prompt Timeout

Configure the number of seconds to wait for the setup hot key.

Bootup Num-Lock

Select whether Num Lock should be turned on or off when the system boots up.

Boot Beep

Select whether the Boot Beep should be turned on or off when the system boots up. Please note that a buzzer is needed.

Full Screen Logo

Enable to display the boot logo or disable to show normal POST messages.

AddOn ROM Display

Enable AddOn ROM Display to see the AddOn ROM messages or configure the AddOn ROM if you've enabled Full Screen Logo. Disable for faster boot speed.

Boot Failure Guard

If the computer fails to boot for a number of times the system automatically restores the default settings.

CSM (Compatibility Support Module)



CSM

Enable to launch the Compatibility Support Module. Please do not disable unless you're running a WHCK test. If you are using Windows 8.1 64-bit and all of your devices support UEFI, you may also disable CSM for faster boot speed.

Launch PXE OpROM Policy

Select UEFI only to run those that support UEFI option ROM only. Select Legacy only to run those that support legacy option ROM only. Do not launch?

Launch Storage OpROM Policy

Select UEFI only to run those that support UEFI option ROM only. Select Legacy only to run those that support legacy option ROM only. Do not launch?

Launch Video OpROM Policy

Select UEFI only to run those that support UEFI option ROM only. Select Legacy only to run those that support legacy option ROM only. Do not launch?

4.8 Exit Screen



Save Changes and Exit

When you select this option the following message, “Save configuration changes and exit setup?” will pop out. Select [OK] to save changes and exit the UEFI SETUP UTILITY.

Discard Changes and Exit

When you select this option the following message, “Discard changes and exit setup?” will pop out. Select [OK] to exit the UEFI SETUP UTILITY without saving any changes.

Discard Changes

When you select this option the following message, “Discard changes?” will pop out. Select [OK] to discard all changes.

Load UEFI Defaults

Load UEFI default values for all options. The F9 key can be used for this operation.

Launch EFI Shell from filesystem device

Copy shellx64.efi to the root directory to launch EFI Shell.

Contact Information

If you need to contact ASRock or want to know more about ASRock, you're welcome to visit ASRock's website at <http://www.asrock.com>; or you may contact your dealer for further information. For technical questions, please submit a support request form at <http://www.asrock.com/support/tsd.asp>

ASRock Incorporation

2F., No.37, Sec. 2, Jhongyang S. Rd., Beitou District,

Taipei City 112, Taiwan (R.O.C.)

ASRock EUROPE B.V.

Bijsterhuizen 3151

6604 LV Wijchen

The Netherlands

Phone: +31-24-345-44-33

Fax: +31-24-345-44-38

ASRock America, Inc.

13848 Magnolia Ave, Chino, CA91710

U.S.A.

Phone: +1-909-590-8308

Fax: +1-909-590-1026