



AD2700B-ITX /
AD2500B-ITX

User Manual

Version 1.0
Published October 2011
Copyright©2011 ASRock INC. All rights reserved.

Copyright Notice:

No part of this manual may be reproduced, transcribed, transmitted, or translated in any language, in any form or by any means, except duplication of documentation by the purchaser for backup purpose, without written consent of ASRock Inc.

Products and corporate names appearing in this manual may or may not be registered trademarks or copyrights of their respective companies, and are used only for identification or explanation and to the owners' benefit, without intent to infringe.

Disclaimer:

Specifications and information contained in this manual are furnished for informational use only and subject to change without notice, and should not be constructed as a commitment by ASRock. ASRock assumes no responsibility for any errors or omissions that may appear in this manual.

With respect to the contents of this manual, ASRock does not provide warranty of any kind, either expressed or implied, including but not limited to the implied warranties or conditions of merchantability or fitness for a particular purpose.

In no event shall ASRock, its directors, officers, employees, or agents be liable for any indirect, special, incidental, or consequential damages (including damages for loss of profits, loss of business, loss of data, interruption of business and the like), even if ASRock has been advised of the possibility of such damages arising from any defect or error in the manual or product.



This device complies with Part 15 of the FCC Rules. Operation is subject to the following two conditions:

- (1) this device may not cause harmful interference, and
- (2) this device must accept any interference received, including interference that may cause undesired operation.

CALIFORNIA, USA ONLY

The Lithium battery adopted on this motherboard contains Perchlorate, a toxic substance controlled in Perchlorate Best Management Practices (BMP) regulations passed by the California Legislature. When you discard the Lithium battery in California, USA, please follow the related regulations in advance.

"Perchlorate Material-special handling may apply, see www.dtsc.ca.gov/hazardouswaste/perchlorate"

ASRock Website: <http://www.asrock.com>

Contents

1 Introduction.....	5
1.1 Package Contents	5
1.2 Specifications.....	6
1.3 Motherboard Layout (AD2700B-ITX).....	11
1.4 Motherboard Layout (AD2500B-ITX).....	12
1.5 I/O Panel (AD2700B-ITX)	13
1.6 I/O Panel (AD2500B-ITX)	14
2 Installation.....	15
2.1 Screw Holes.....	15
2.2 Pre-installation Precautions	15
2.3 Installation of Memory Modules (SO-DIMM).....	16
2.4 Expansion Slot (PCI Slot).....	17
2.5 ASRock Smart Remote Installation Guide	18
2.6 Jumpers Setup	19
2.7 Onboard Headers and Connectors	20
2.8 Serial ATA (SATA) / Serial ATA2 (SATA2) Hard Disks Installation	23
2.9 Hot Plug and Hot Swap Functions for SATA / SATA2 HDDs	23
2.10 SATA / SATA2 HDD Hot Plug Feature and Operation Guide	24
2.11 Driver Installation Guide	26
2.12 Installing Windows® 7 on SATA / SATAII HDDs	26
3 UEFI SETUP UTILITY	27
3.1 Introduction.....	27
3.1.1 UEFI Menu Bar	27
3.1.2 Navigation Keys	28
3.2 Main Screen.....	28
3.3 Advanced Screen.....	30
3.3.1 CPU Configuration	31
3.3.2 Chipset Configuration.....	32
3.3.3 Storage Configuration	33
3.3.4 Super IO Configuration	34
3.3.5 ACPI Configuration.....	35
3.3.6 USB Configuration	36
3.3.7 Voltage Configuration.....	37
3.4 Hardware Health Event Monitoring Screen	38
3.5 Boot Screen	39

3.6 Security Screen	40
3.7 Exit Screen	41
4 Software Support.....	42
4.1 Install Operating System.....	42
4.2 Support CD Information.....	42
4.2.1 Running Support CD.....	42
4.2.2 Drivers Menu.....	42
4.2.3 Utilities Menu.....	42
4.2.4 Contact Information.....	42

Chapter 1: Introduction

Thank you for purchasing ASRock **AD2700B-ITX / AD2500B-ITX** motherboard, a reliable motherboard produced under ASRock's consistently stringent quality control. It delivers excellent performance with robust design conforming to ASRock's commitment to quality and endurance.

In this manual, chapter 1 and 2 contain introduction of the motherboard and step-by-step guide to the hardware installation. Chapter 3 and 4 contain the configuration guide to BIOS setup and information of the Support CD.



Because the motherboard specifications and the BIOS software might be updated, the content of this manual will be subject to change without notice. In case any modifications of this manual occur, the updated version will be available on ASRock website without further notice. You may find the latest VGA cards and CPU support lists on ASRock website as well. ASRock website <http://www.asrock.com>
If you require technical support related to this motherboard, please visit our website for specific information about the model you are using.
www.asrock.com/support/index.asp

1.1 Package Contents

ASRock **AD2700B-ITX / AD2500B-ITX** Motherboard

(Mini-ITX Form Factor: 6.7-in x 6.7-in, 17.0 cm x 17.0 cm)

ASRock **AD2700B-ITX / AD2500B-ITX** Quick Installation Guide

ASRock **AD2700B-ITX / AD2500B-ITX** Support CD

2 x Serial ATA (SATA) Data Cables (Optional)

1 x I/O Panel Shield

1.2 Specifications

Platform	<ul style="list-style-type: none"> - Mini-ITX Form Factor: 6.7-in x 6.7-in, 17.0 cm x 17.0 cm - All Solid Capacitor design (AD2700B-ITX) - Solid Capacitor for CPU power (AD2500B-ITX)
CPU	<ul style="list-style-type: none"> - Intel® Dual-Core Atom™ Processor D2700 (2.13 GHz) (AD2700B-ITX) - Intel® Dual-Core Atom™ Processor D2500 (1.86 GHz) (AD2500B-ITX) - Supports Hyper-Threading Technology (AD2700B-ITX) (see CAUTION 1)
Chipset	- Southbridge: Intel® NM10 Express
Memory	<ul style="list-style-type: none"> - 2 x DDR3 SO-DIMM slots - Supports DDR3 1066/800 non-ECC, un-buffered memory - Max. capacity of system memory: 4GB (see CAUTION 2)
Expansion Slot	- 1 x PCI slot
Graphics	<ul style="list-style-type: none"> - Intel® PowerVR SGX545 - DirectX 9.0, Pixel Shader 3.0 - Supports D-Sub with max. resolution up to 1920x1200 @ 60Hz
Audio	- 5.1 CH HD Audio (VIA® VT1705 Audio Codec)
LAN (AD2700B-ITX)	<ul style="list-style-type: none"> - PCIE x1 Gigabit LAN 10/100/1000 Mb/s - Realtek RTL8111E - Supports Wake-On-LAN - Supports LAN Cable Detection - Supports Energy Efficient Ethernet 802.3az - Supports PXE
LAN (AD2500B-ITX)	<ul style="list-style-type: none"> - Realtek PCIE x1 LAN RTL8105E - Speed: 10/100 Ethernet - Supports Wake-On-LAN - Supports PXE
Rear Panel I/O (AD2700B-ITX)	<p>I/O Panel</p> <ul style="list-style-type: none"> - 1 x PS/2 Mouse Port - 1 x PS/2 Keyboard Port - 1 x Parallel Port (ECP/EPP Support) - 1 x Serial Port: COM1 - 1 x VGA Port - 2 x Ready-to-Use USB 2.0 Ports - 2 x Ready-to-Use USB 3.0 Ports

	<ul style="list-style-type: none"> - 1 x RJ-45 LAN Port with LED (ACT/LINK LED and SPEED LED) - HD Audio Jack: Line in/Front Speaker/Microphone
Rear Panel I/O (AD2500B-ITX)	<p>I/O Panel</p> <ul style="list-style-type: none"> - 1 x PS/2 Mouse Port - 1 x PS/2 Keyboard Port - 1 x Parallel Port (ECP/EPP Support) - 1 x Serial Port: COM1 - 1 x VGA Port - 4 x Ready-to-Use USB 2.0 Ports - 1 x RJ-45 LAN Port with LED (ACT/LINK LED and SPEED LED) - HD Audio Jack: Line in/Front Speaker/Microphone
USB 3.0 (AD2700B-ITX)	<ul style="list-style-type: none"> - 2 x USB 3.0 ports by ASMedia ASM1042, support USB 1.0/2.0/3.0 up to 5Gb/s
Connector	<ul style="list-style-type: none"> - 2 x SATA2 3.0 Gb/s connectors, support NCQ, AHCI and Hot Plug functions - 1 x IR header - 1 x CIR header - CPU/Chassis FAN connector - 24 pin ATX power connector - Front panel audio connector - 2 x USB 2.0 headers (support 4 USB 2.0 ports)
BIOS Feature	<ul style="list-style-type: none"> - 16Mb AMI BIOS - AMI UEFI Legal BIOS with GUI support - Supports "Plug and Play" - ACPI 1.1 Compliance Wake Up Events - Supports jumperfree - SMBIOS 2.3.1 Support
Support CD	<ul style="list-style-type: none"> - Drivers, Utilities, AntiVirus Software (Trial Version), CyberLink MediaEspresso 6.5 Trial, ASRock Software Suite (CyberLink DVD Suite - OEM and Trial; Creative Sound Blaster X-Fi MB - Trial; ASRock MAGIX Multimedia Suite - OEM)
Unique Feature	<ul style="list-style-type: none"> - ASRock Instant Boot - ASRock Instant Flash (see CAUTION 3) - ASRock APP Charger (see CAUTION 4) - ASRock SmartView (see CAUTION 5) - ASRock XFast USB (see CAUTION 6) - ASRock XFast LAN (see CAUTION 7)

	<ul style="list-style-type: none"> - Hybrid Booster: <ul style="list-style-type: none"> - CPU Frequency Stepless Control (see CAUTION 8) - ASRock U-COP (see CAUTION 9) - Boot Failure Guard (B.F.G.)
Hardware Monitor	<ul style="list-style-type: none"> - CPU Temperature Sensing - Chassis Temperature Sensing - CPU Fan Tachometer - Chassis Fan Tachometer - CPU/Chassis Quiet Fan - Voltage Monitoring: +12V, +5V, +3.3V, CPU Vcore
OS	<ul style="list-style-type: none"> - Microsoft® Windows® 7 32-bit compliant
Certifications	<ul style="list-style-type: none"> - FCC, CE, WHQL - ErP/EuP Ready (ErP/EuP ready power supply is required) (see CAUTION 10)

* For detailed product information, please visit our website: <http://www.asrock.com>

WARNING

Please realize that there is a certain risk involved with overclocking, including adjusting the setting in the BIOS, applying Untied Overclocking Technology, or using the third-party overclocking tools. Overclocking may affect your system stability, or even cause damage to the components and devices of your system. It should be done at your own risk and expense. We are not responsible for possible damage caused by overclocking.

CAUTION!

1. About the setting of "Hyper Threading Technology", please check page 31.
2. Due to the chipset limitation, the actual memory size may be less than 4GB for the reservation for system usage under Windows® OS.
3. ASRock Instant Flash is a BIOS flash utility embedded in Flash ROM. This convenient BIOS update tool allows you to update system BIOS without entering operating systems like MS-DOS or Windows®. With this utility, you can press the <F6> key during the POST or the <F2> key to enter into the BIOS setup menu to access ASRock Instant Flash. Just launch this tool and save the new BIOS file to your USB flash drive, floppy disk or hard drive, then you can update your BIOS only in a few clicks without preparing an additional floppy diskette or other complicated flash utility. Please be noted that the USB flash drive or hard drive must use FAT32/16/12 file system.
4. If you desire a faster, less restricted way of charging your Apple devices, such as iPhone/iPad/iPod Touch, ASRock has prepared a wonderful solution for you - ASRock APP Charger. Simply install the APP Charger driver, it makes your iPhone charge much quickly from your computer and up to 40% faster than before. ASRock APP Charger allows you to quickly charge many Apple devices simultaneously and even supports continuous charging when your PC enters into Standby mode (S1), Suspend to RAM (S3), hibernation mode (S4) or power off (S5). With APP Charger driver installed, you can easily enjoy the marvelous charging experience. ASRock website: <http://www.asrock.com/Feature/AppCharger/index.asp>
5. ASRock SmartView, a new function for internet browsers, is the smart start page for IE that combines your most visited web sites, your history, your Facebook friends and your real-time newsfeed into an enhanced view for a more personal Internet experience. ASRock motherboards are exclusively equipped with the ASRock SmartView utility that helps you keep in touch with friends on-the-go. To use ASRock SmartView feature, please make sure your OS version is Windows® 7, and your browser version is IE8. ASRock website: <http://www.asrock.com/Feature/SmartView/index.asp>
6. ASRock XFast USB can boost USB storage device performance. The performance may depend on the properties of the device.
7. ASRock XFast LAN provides a faster internet access, which includes the benefits listed below. LAN Application Prioritization: You can configure your application's priority ideally and/or add new programs. Lower Latency in Game: After setting online game's priority higher, it can lower the latency in games. Traffic Shaping: You can watch Youtube HD videos and download simultaneously. Real-Time Analysis of Your Data: With the status window, you can easily recognize which data streams you are transferring currently.

-
8. Although this motherboard offers stepless control, it is not recommended to perform over-clocking. Frequencies other than the recommended CPU bus frequencies may cause instability of the system or damage the CPU.
 9. While CPU overheat is detected, the system will automatically shutdown. Before you resume the system, please check if the CPU fan on the motherboard functions properly and unplug the power cord, then plug it back again. To improve heat dissipation, remember to spray thermal grease between the CPU and the heatsink when you install the PC system.
 10. EuP stands for Energy Using Product, was a provision regulated by the European Union to define the power consumption for the completed system. According to EuP, the total AC power of the completed system should be under 1.00W in off mode condition. To meet EuP standards, an EuP ready motherboard and an EuP ready power supply are required. According to Intel's suggestion, the EuP ready power supply must meet the standard of 5v, and the standby power efficiency should be higher than 50% under 100 mA current consumption. For EuP ready power supply selection, we recommend you to check with the power supply manufacturer for more details.

1.3 Motherboard Layout (AD2700B-ITX)

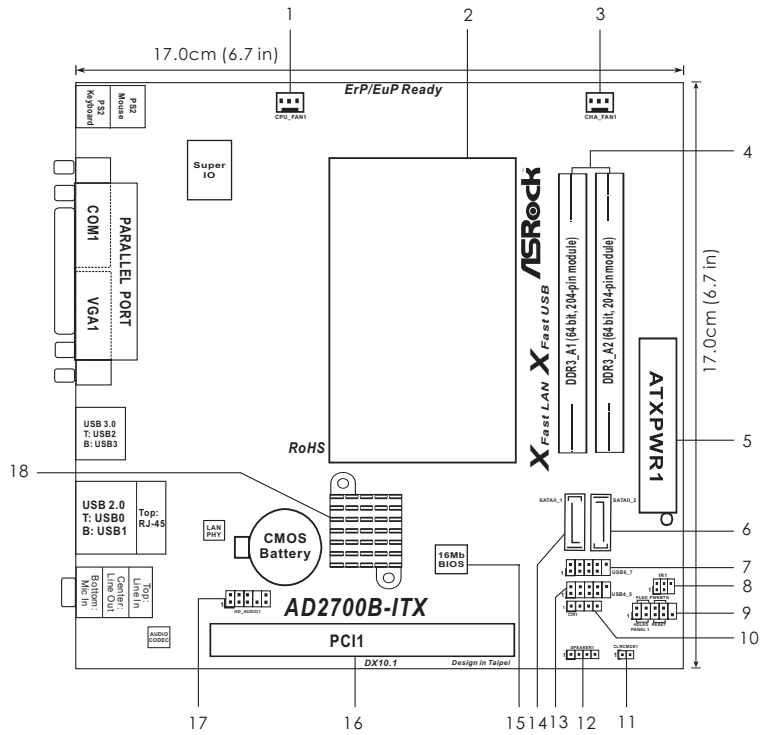

- | | | | |
|----|--|----|---|
| 1 | CPU Fan Connector (CPU_FAN1) | 11 | Clear CMOS Jumper (CLRCMOS1) |
| 2 | CPU Heatsink | 12 | Chassis Speaker Header (SPEAKER 1, White) |
| 3 | Chassis Fan Connector (CHA_FAN1) | 13 | USB 2.0 Header (USB4_5, Blue) |
| 4 | 2 x 204-pin DDR3 SO-DIMM Slots (DDR3_A1, DDR3_A2, Black) | 14 | SATA2 Connector (SATA11_1, Blue) |
| 5 | ATX Power Connector (ATXPWR1) | 15 | 16Mb SPI Flash |
| 6 | SATA2 Connector (SATA11_2, Blue) | 16 | PCI Slot (PCI1) |
| 7 | USB 2.0 Header (USB6_7, Blue) | 17 | Front Panel Audio Header (HD_AUDIO1, White) |
| 8 | Infrared Module Header (IR1) | 18 | Intel NM10 Express Chip |
| 9 | System Panel Header (PANEL1, White) | | |
| 10 | Consumer Infrared Module Header (CIR1) | | |

1.4 Motherboard Layout (AD2500B-ITX)

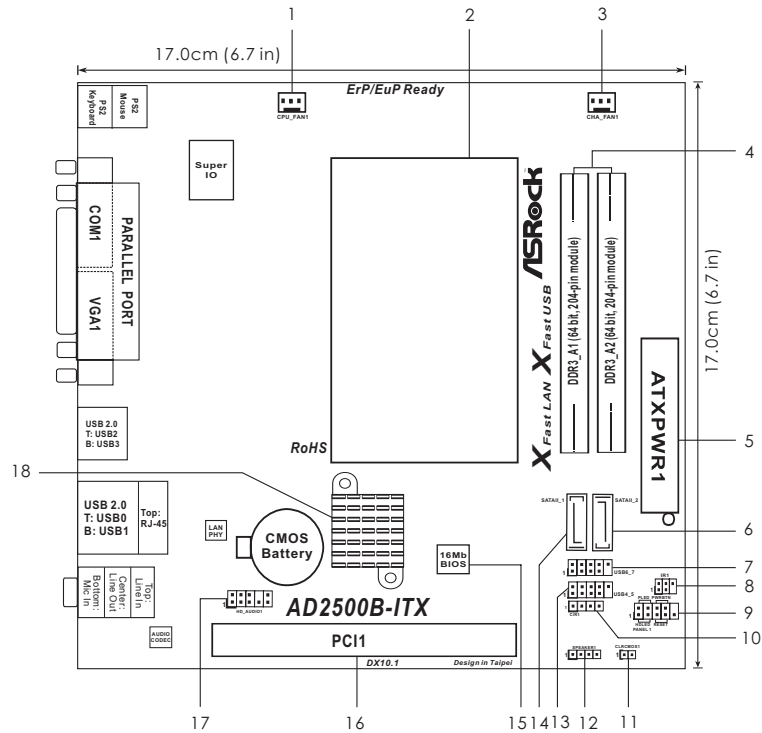

- | | | | |
|----|--|----|---|
| 1 | CPU Fan Connector (CPU_FAN1) | 11 | Clear CMOS Jumper (CLRCMOS1) |
| 2 | CPU Heatsink | 12 | Chassis Speaker Header (SPEAKER 1, White) |
| 3 | Chassis Fan Connector (CHA_FAN1) | 13 | USB 2.0 Header (USB4_5, Blue) |
| 4 | 2 x 204-pin DDR3 SO-DIMM Slots (DDR3_A1, DDR3_A2, Black) | 14 | SATA2 Connector (SATA1_1, Blue) |
| 5 | ATX Power Connector (ATXPWR1) | 15 | 16Mb SPI Flash |
| 6 | SATA2 Connector (SATA1_2, Blue) | 16 | PCI Slot (PCI1) |
| 7 | USB 2.0 Header (USB6_7, Blue) | 17 | Front Panel Audio Header (HD_AUDIO1, White) |
| 8 | Infrared Module Header (IR1) | 18 | Intel NM10 Express Chip |
| 9 | System Panel Header (PANEL1, White) | | |
| 10 | Consumer Infrared Module Header (CIR1) | | |

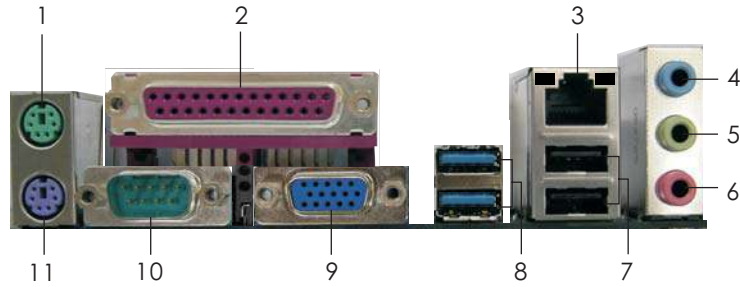

1.5 I/O Panel (AD2700B-ITX)



- | | |
|---------------------------|--------------------------------|
| 1 PS/2 Mouse Port (Green) | 7 USB 2.0 Ports (USB01) |
| 2 Parallel Port | 8 USB 3.0 Ports (USB23) |
| * 3 LAN RJ-45 Port | 9 VGA Port |
| 4 Line In (Light Blue) | 10 COM Port |
| 5 Front Speaker (Lime) | 11 PS/2 Keyboard Port (Purple) |
| 6 Microphone (Pink) | |

* There are two LED next to the LAN port. Please refer to the table below for the LAN port LED indications.

LAN Port LED Indications

Activity/Link LED		SPEED LED		ACT/LINK LED	SPEED LED
Status	Description	Status	Description	LED	LED
Off	No Link	Off	10Mbps connection		
Blinking	Data Activity	Orange	100Mbps connection		
On	Link	Green	1Gbps connection		

To enable Multi-Streaming function, you need to connect a front panel audio cable to the front panel audio header. After restarting your computer, you will find "VIA HD Audio Deck" tool on your system. Please follow below instructions according to the OS you install.

Please click "VIA HD Audio Deck" icon , and click "Advanced Options" on the left side on the bottom. In "Advanced Options" screen, select "Independent Headphone", and click "OK" to save your change.

1.6 I/O Panel (AD2500B-ITX)

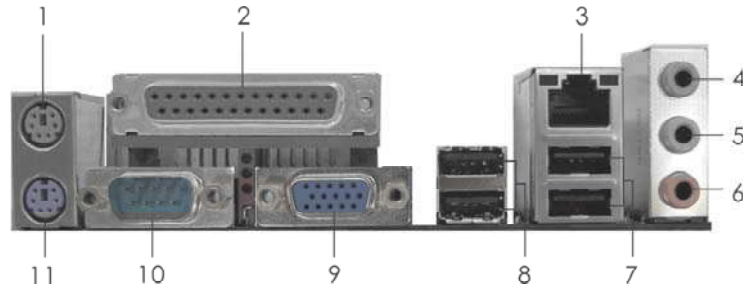

- | | |
|---------------------------|--------------------------------|
| 1 PS/2 Mouse Port (Green) | 7 USB 2.0 Ports (USB01) |
| 2 Parallel Port | 8 USB 2.0 Ports (USB23) |
| * 3 LAN RJ-45 Port | 9 VGA Port |
| 4 Line In (Light Blue) | 10 COM Port |
| 5 Front Speaker (Lime) | 11 PS/2 Keyboard Port (Purple) |
| 6 Microphone (Pink) | |

* There are two LED next to the LAN port. Please refer to the table below for the LAN port LED indications.

LAN Port LED Indications

Activity/Link LED		SPEED LED		ACT/LINK LED	SPEED LED
Status	Description	Status	Description		
Off	No Link	Off	10Mbps connection		
Blinking	Data Activity	Orange	100Mbps connection		
On	Link				

To enable Multi-Streaming function, you need to connect a front panel audio cable to the front panel audio header. After restarting your computer, you will find "VIA HD Audio Deck" tool on your system. Please follow below instructions according to the OS you install.

Please click "VIA HD Audio Deck" icon , and click "Advanced Options" on the left side on the bottom. In "Advanced Options" screen, select "Independent Headphone", and click "OK" to save your change.

Chapter 2: Installation_

This is a Mini-ITX form factor (6.7" x 6.7", 17.0 x 17.0 cm) motherboard. Before you install the motherboard, study the configuration of your chassis to ensure that the motherboard fits into it.



Make sure to unplug the power cord before installing or removing the motherboard. Failure to do so may cause physical injuries to you and damages to motherboard components.

2.1 Screw Holes

Place screws into the holes indicated by circles to secure the motherboard to the chassis.



Do not over-tighten the screws! Doing so may damage the motherboard.

2.2 Pre-installation Precautions

Take note of the following precautions before you install motherboard components or change any motherboard settings.

1. Unplug the power cord from the wall socket before touching any component.
2. To avoid damaging the motherboard components due to static electricity, NEVER place your motherboard directly on the carpet or the like. Also remember to use a grounded wrist strap or touch a safety grounded object before you handle components.
3. Hold components by the edges and do not touch the ICs.
4. Whenever you uninstall any component, place it on a grounded antistatic pad or in the bag that comes with the component.



Before you install or remove any component, ensure that the power is switched off or the power cord is detached from the power supply. Failure to do so may cause severe damage to the motherboard, peripherals, and/or components.

2.3 Installation of Memory Modules (SO-DIMM)

AD2700B-ITX / AD2500B-ITX motherboard provides two 204-pin DDR3 (Double Data Rate 3) SO-DIMM slots.



1. It is not allowed to install a DDR or DDR2 memory module into DDR3 slot; otherwise, this motherboard and SO-DIMM may be damaged.
2. Please install the memory module from DDR3_A2 slot for the 1st priority.

Installing a SO-DIMM



Please make sure to disconnect power supply before adding or removing SO-DIMMs or the system components.

- Step 1. Unlock a SO-DIMM slot by pressing the retaining clips outward.
- Step 2. Align a SO-DIMM on the slot such that the notch on the SO-DIMM matches the break on the slot.

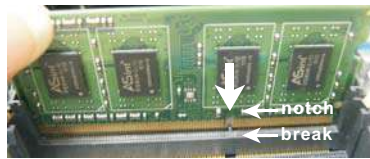

The SO-DIMM only fits in one correct orientation. It will cause permanent damage to the motherboard and the SO-DIMM if you force the SO-DIMM into the slot at incorrect orientation.

- Step 3. Firmly insert the SO-DIMM into the slot until the retaining clips at both ends fully snap back in place and the SO-DIMM is properly seated.

2.4 Expansion Slot (PCI Slot)

There is 1 PCI slot on this motherboard.

PCI slot: The PCI slot is used to install expansion card that has the 32-bit PCI interface.

Installing an expansion card

- Step 1. Before installing the expansion card, please make sure that the power supply is switched off or the power cord is unplugged. Please read the documentation of the expansion card and make necessary hardware settings for the card before you start the installation.
- Step 2. Remove the system unit cover (if your motherboard is already installed in a chassis).
- Step 3. Remove the bracket facing the slot that you intend to use. Keep the screws for later use.
- Step 4. Align the card connector with the slot and press firmly until the card is completely seated on the slot.
- Step 5. Fasten the card to the chassis with screws.
- Step 6. Replace the system cover.

2.5 ASRock Smart Remote Installation Guide

ASRock Smart Remote is only used for ASRock motherboard with CIR header. Please refer to below procedures for the quick installation and usage of ASRock Smart Remote.

Step1. Find the CIR header located next to the USB 2.0 header on ASRock motherboard.



Step2. Connect the front USB cable to the USB 2.0 header (as below, pin 1-5) and the CIR header. Please make sure the wire assignments and the pin assignments are matched correctly.

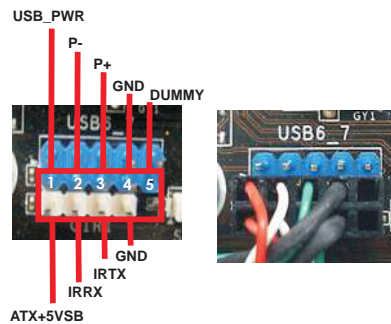

Step3. Install Multi-Angle CIR Receiver to the front USB port. If Multi-Angle CIR Receiver cannot successfully receive the infrared signals from MCE Remote Controller, please try to install it to the other front USB port.

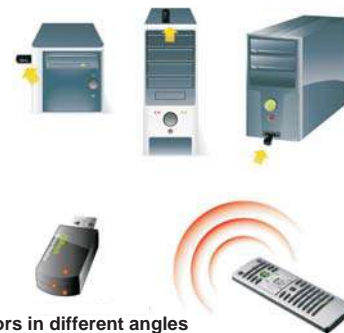

3 CIR sensors in different angles





1. Only one of the front USB port can support CIR function. When the CIR function is enabled, the other port will remain USB function.
2. Multi-Angle CIR Receiver is used for front USB only. Please do not use the rear USB bracket to connect it on the rear panel. Multi-Angle CIR Receiver can receive the multi-direction infrared signals (top, down and front), which is compatible with most of the chassis on the market.
3. The Multi-Angle CIR Receiver does not support Hot-Plug function. Please install it before you boot the system.

* ASRock Smart Remote is only supported by some of ASRock motherboards. Please refer to ASRock website for the motherboard support list: <http://www.asrock.com>

2.6 Jumpers Setup

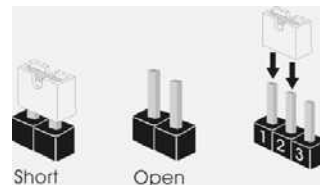
The illustration shows how jumpers are setup. When the jumper cap is placed on pins, the jumper is "Short". If no jumper cap is placed on pins, the jumper is "Open". The illustration shows a 3-pin jumper whose pin1 and pin2 are "Short" when jumper cap is placed on these 2 pins.



Jumper	Setting	Description
Clear CMOS (CLRCMOS1, 2-pin jumper) (see p.11 or 12 No. 11)	 2-pin jumper	

Note: CLRCMOS1 allows you to clear the data in CMOS. The data in CMOS includes system setup information such as system password, date, time, and system setup parameters. To clear and reset the system parameters to default setup, please turn off the computer and unplug the power cord from the power supply. After waiting for 15 seconds, use a jumper cap to short 2 pins on CLRCMOS1 for 5 seconds.

2.7 Onboard Headers and Connectors



Onboard headers and connectors are NOT jumpers. Do NOT place jumper caps over these headers and connectors. Placing jumper caps over the headers and connectors will cause permanent damage of the motherboard!

Serial ATA2 Connectors

(SATAII_1: see p.11 or 12, No. 14)

(SATAII_2: see p.11 or 12, No. 6)



These two Serial ATA2 (SATA2) connectors support SATA data cables for internal storage devices. The current SATA2 interface allows up to 3.0 Gb/s data transfer rate.

Serial ATA (SATA)

Data Cable

(Optional)



Either end of the SATA data cable can be connected to the SATA / SATA2 hard disk or the SATA2 connector on this motherboard.

USB 2.0 Headers

(9-pin USB4_5)

(see p.11 or 12 No. 13)

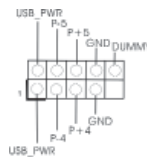

(9-pin USB6_7)

(see p.11 or 12 No. 7)

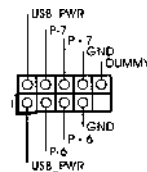

Besides the default USB 2.0 ports on the I/O panel, there are two USB 2.0 headers on this motherboard. Each USB 2.0 header can support two USB 2.0 ports.

Consumer Infrared Module Header

(4-pin CIR1)

(see p.11 or 12 No. 10)



This header can be used to connect the remote controller receiver.

Infrared Module Header

(5-pin IR1)

(see p.11 or 12 No. 8)

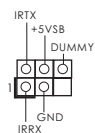

This header supports an optional wireless transmitting and receiving infrared module.

Front Panel Audio Header

(9-pin HD_AUDIO1)

(see p.11 or 12 No. 17)

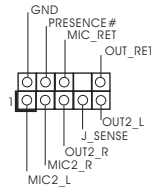

This is an interface for front panel audio cable that allows convenient connection and control of audio devices.



1. High Definition Audio supports Jack Sensing, but the panel wire on the chassis must support HDA to function correctly. Please follow the instruction in our manual and chassis manual to install your system.
2. If you use AC'97 audio panel, please install it to the front panel audio header as below:
 - A. Connect Mic_IN (MIC) to MIC2_L.
 - B. Connect Audio_R (RIN) to OUT2_R and Audio_L (LIN) to OUT2_L.
 - C. Connect Ground (GND) to Ground (GND).
 - D. MIC_RET and OUT_RET are for HD audio panel only. You don't need to connect them for AC'97 audio panel.

System Panel Header

(9-pin PANEL1)

(see p.11 or 12 No. 9)

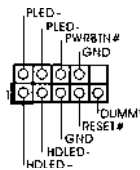

This header accommodates several system front panel functions.



Connect the power switch, reset switch and system status indicator on the chassis to this header according to the pin assignments below. Note the positive and negative pins before connecting the cables.

PWRBTN (Power Switch):

Connect to the power switch on the chassis front panel. You may configure the way to turn off your system using the power switch.

RESET (Reset Switch):

Connect to the reset switch on the chassis front panel. Press the reset switch to restart the computer if the computer freezes and fails to perform a normal restart.

PLED (System Power LED):

Connect to the power status indicator on the chassis front panel. The LED is on when the system is operating. The LED keeps blinking when the system is in S1 sleep state. The LED is off when the system is in S3/S4 sleep state or powered off (S5).

HDLED (Hard Drive Activity LED):

Connect to the hard drive activity LED on the chassis front panel. The LED is on when the hard drive is reading or writing data.

The front panel design may differ by chassis. A front panel module mainly consists of power switch, reset switch, power LED, hard drive activity LED, speaker and etc. When connecting your chassis front panel module to this header, make sure the wire assignments and the pin assignments are matched correctly.

Chassis Speaker Header

(4-pin SPEAKER 1)
(see p.11 or 12 No. 12)

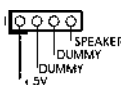

Please connect the chassis speaker to this header.

Chassis Fan Connector

(3-pin CHA_FAN1)
(see p.11 or 12 No. 3)

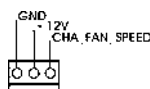

Please connect the fan cable to the fan connector and match the black wire to the ground pin.

CPU Fan Connector

(3-pin CPU_FAN1)
(see p.11 or 12 No. 1)

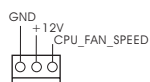

Please connect the CPU fan cable to the connector and match the black wire to the ground pin.

ATX Power Connector

(24-pin ATXPWR1)
(see p.11 or 12 No. 5)

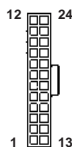

Please connect an ATX power supply to this connector.



Though this motherboard provides 24-pin ATX power connector, it can still work if you adopt a traditional 20-pin ATX power supply. To use the 20-pin ATX power supply, please plug your power supply along with Pin 1 and Pin 13.



20-Pin ATX Power Supply Installation

1 13

2.8 Serial ATA (SATA) / Serial ATAII (SATAII) Hard Disks Installation

This motherboard adopts Intel® NM10 Express chipset that supports Serial ATA (SATA) / Serial ATAII (SATAII) hard disks. You may install SATA / SATAII hard disks on this motherboard for internal storage devices. This section will guide you to install the SATA / SATAII hard disks.

STEP 1: Install the SATA / SATAII hard disks into the drive bays of your chassis.

STEP 2: Connect the SATA power cable to the SATA / SATAII hard disk.

STEP 3: Connect one end of the SATA data cable to the motherboard's SATAII connector.

STEP 4: Connect the other end of the SATA data cable to the SATA / SATAII hard disk.

2.9 Hot Plug Function for SATA / SATAII HDDs

This motherboard supports Hot Plug function for SATA / SATAII in AHCI mode. Intel® NM10 Express chipset provides hardware support for Advanced Host controller Interface (AHCI), a new programming interface for SATA host controllers developed thru a joint industry effort.



NOTE

What is Hot Plug Function?

If the SATA / SATAII HDDs are NOT set for RAID configuration, it is called "Hot Plug" for the action to insert and remove the SATA / SATAII HDDs while the system is still power-on and in working condition.

However, please note that it cannot perform Hot Plug if the OS has been installed into the SATA / SATAII HDD.

2.10 SATA / SATAII HDD Hot Plug Feature and Operation Guide

This motherboard supports Hot Plug feature for SATA / SATAII HDD in AHCI mode. Please read below operation guide of Hot Plug feature carefully. Before you process the SATA / SATAII HDD Hot Plug, please check below cable accessories from the motherboard gift box pack.

A. 7-pin SATA data cable

B. SATA power cable with SATA 15-pin power connector interface

A. SATA data cable (Red)

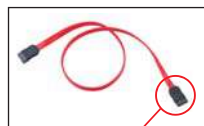

SATA 7-pin
connector

B. SATA power cable



The SATA 15-pin power
connector (Black) connect
to SATA / SATAII HDD

1x4-pin conventional
power connector (White)
connect to power supply

Caution

1. Without SATA 15-pin power connector interface, the SATA / SATAII Hot Plug cannot be processed.
2. Even some SATA / SATAII HDDs provide both SATA 15-pin power connector and IDE 1x4-pin conventional power connector interfaces, the IDE 1x4-pin conventional power connector interface is definitely not able to support Hot Plug and will cause the HDD damage and data loss.

Points of attention, before you process the Hot Plug:

1. Below operation procedure is designed only for our motherboard, which supports SATA / SATAII HDD Hot Plug.
 - * The SATA / SATAII Hot Plug feature might not be supported by the chipset because of its limitation, the SATA / SATAII Hot Plug support information of our motherboard is indicated in the product spec on our website: www.asrock.com
2. Make sure your SATA / SATAII HDD can support Hot Plug function from your dealer or HDD user manual. The SATA / SATAII HDD, which cannot support Hot Plug function, will be damaged under the Hot Plug operation.
3. Please make sure the SATA / SATAII driver is installed into system properly. The latest SATA / SATAII driver is available on our support website: www.asrock.com
4. Make sure to use the SATA power cable & data cable, which are from our motherboard package.
5. Please follow below instructions step by step to reduce the risk of HDD crash or data loss.

How to Hot Plug a SATA / SATAII HDD:

Points of attention, before you process the Hot Plug:

Please do follow below instruction sequence to process the Hot Plug, improper procedure will cause the SATA / SATAII HDD damage and data loss.

Step 1 Please connect SATA power cable 1x4-pin end (White) to the power supply 1x4-pin cable.

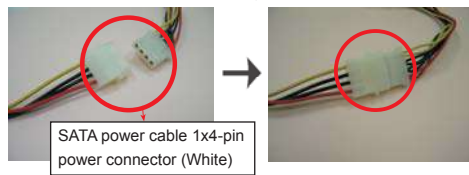

Step 2 Connect SATA data cable to the motherboard's SATAII connector.

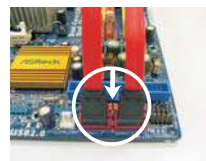

Step 3 Connect SATA 15-pin power cable connector (Black) end to SATA / SATAII HDD.



Step 4 Connect SATA data cable to the SATA / SATAII HDD.



How to Hot Unplug a SATA / SATAII HDD:

Points of attention, before you process the Hot Unplug:

Please do follow below instruction sequence to process the Hot Unplug, improper procedure will cause the SATA / SATAII HDD damage and data loss.

Step 1 Unplug SATA data cable from SATA / SATAII HDD side.

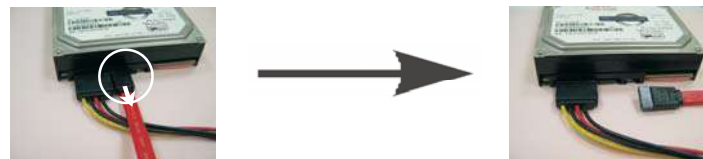

Step 2 Unplug SATA 15-pin power cable connector (Black) from SATA / SATAII HDD side.



2.11 Driver Installation Guide

To install the drivers to your system, please insert the support CD to your optical drive first. Then, the drivers compatible to your system can be auto-detected and listed on the support CD driver page. Please follow the order from up to bottom side to install those required drivers. Therefore, the drivers you install can work properly.

2.12 Installing Windows® 7 on SATA / SATAII HDDs

If you want to install Windows® 7 OS on your SATA / SATAII HDDs, please follow below steps.

Using SATA / SATAII HDDs with NCQ function

STEP 1: Set up UEFI.

- A. Enter UEFI SETUP UTILITY → Advanced screen → Storage Configuration.
- B. Set the option "SATA Mode" to [AHCI].

STEP 2: Install Windows® 7 OS on your system.

Using SATA / SATAII HDDs without NCQ function

STEP 1: Set up UEFI.

- A. Enter UEFI SETUP UTILITY → Advanced screen → Storage Configuration.
- B. Set the option "SATA Mode" to [IDE].

STEP 2: Install Windows® 7 OS on your system.

Chapter 3: UEFI SETUP UTILITY

3.1 Introduction

This section explains how to use the UEFI SETUP UTILITY to configure your system. The UEFI chip on the motherboard stores the UEFI SETUP UTILITY. You may run the UEFI SETUP UTILITY when you start up the computer. Please press <F2> or during the Power-On-Self-Test (POST) to enter the UEFI SETUP UTILITY, otherwise, POST will continue with its test routines.

If you wish to enter the UEFI SETUP UTILITY after POST, restart the system by pressing <Ctl> + <Alt> + <Delete>, or by pressing the reset button on the system chassis. You may also restart by turning the system off and then back on.



Because the UEFI software is constantly being updated, the following UEFI setup screens and descriptions are for reference purpose only, and they may not exactly match what you see on your screen.

3.1.1 UEFI Menu Bar

The top of the screen has a menu bar with the following selections:

Main	To set up the system time/date information
OC Tweaker	To set up overclocking features
Advanced	To set up the advanced UEFI features
H/W Monitor	To display current hardware status
Boot	To set up the default system device to locate and load the Operating System
Security	To set up the security features
Exit	To exit the current screen or the UEFI SETUP UTILITY

Use <←> key or <→> key to choose among the selections on the menu bar, and then press <Enter> to get into the sub screen. You can also use the mouse to click your required item.

3.1.2 Navigation Keys

Please check the following table for the function description of each navigation key.

Navigation Key(s)	Function Description
← / →	Moves cursor left or right to select Screens
↑ / ↓	Moves cursor up or down to select items
+ / -	To change option for the selected items
<Enter>	To bring up the selected screen
<F1>	To display the General Help Screen
<F9>	To load optimal default values for all the settings
<F10>	To save changes and exit the UEFI SETUP UTILITY
<ESC>	To jump to the Exit Screen or exit the current screen

3.2 Main Screen

When you enter the UEFI SETUP UTILITY, the Main screen will appear and display the system overview.

AD2700B-ITX



AD2500B-ITX



3.3 Advanced Screen

In this section, you may set the configurations for the following items: CPU Configuration, Chipset Configuration, Storage Configuration, Super IO Configuration, ACPI Configuration, USB Configuration and Voltage Configuration.



Setting wrong values in this section may cause the system to malfunction.

Instant Flash

Instant Flash is a UEFI flash utility embedded in Flash ROM. This convenient UEFI update tool allows you to update system UEFI without entering operating systems first like MS-DOS or Windows®. Just launch this tool and save the new UEFI file to your USB flash drive, floppy disk or hard drive, then you can update your UEFI only in a few clicks without preparing an additional floppy diskette or other complicated flash utility. Please be noted that the USB flash drive or hard drive must use FAT32/16/12 file system. If you execute Instant Flash utility, the utility will show the UEFI files and their respective information. Select the proper UEFI file to update your UEFI, and reboot your system after UEFI update process completes.

3.3.1 CPU Configuration



Intel Hyper Threading Technology

To enable this feature, it requires a computer system with an Intel processor that supports Hyper-Threading technology and an operating system that includes optimization for this technology, such as Microsoft® Windows® 7. Set to [Enabled] if using Microsoft® Windows® 7.

No-Execute Memory Protection

No-Execution (NX) Memory Protection Technology is an enhancement to the IA-32 Intel Architecture. An IA-32 processor with "No Execute (NX) Memory Protection" can prevent data pages from being used by malicious software to execute code.

3.3.2 Chipset Configuration



ACPI HPET Table

Use this item to enable or disable ACPI HPET Table. The default value is [Enabled]. Please set this option to [Enabled] if you plan to use this motherboard to submit Windows® certification.

Restore on AC/Power Loss

This allows you to set the power state after an unexpected AC/power loss. If [Power Off] is selected, the AC/power remains off when the power recovers. If [Power On] is selected, the AC/power resumes and the system starts to boot up when the power recovers.

Onboard HD Audio

Select [Auto], [Enabled] or [Disabled] for the onboard HD Audio feature. If you select [Auto], the onboard HD Audio will be disabled when PCI Sound Card is plugged.

Front Panel

Select [Auto] or [Disabled] for the onboard HD Audio Front Panel.

Onboard LAN

This allows you to enable or disable the "Onboard LAN" feature.

Good Night LED

Enable this option to turn off Power LED when the system is power on. The keyboard LED will also be turned off in S1, S3 and S4 state. The default value is [Auto].

3.3.3 Storage Configuration



SATA2 Mode

Use this to select SATA2 mode. Configuration options: [IDE Mode], [AHCI Mode] and [Disabled]. The default value is [IDE Mode].



AHCI (Advanced Host Controller Interface) supports NCQ and other new features that will improve SATA disk performance but IDE mode does not have these advantages.

3.3.4 Super IO Configuration



COM1 Port

Use this item to enable or disable the onboard serial port.

COM1 Port Address

Use this item to set the address for the onboard serial port. Configuration options: [3F8 / IRQ4] and [3E8 / IRQ4].

IR1 Port

Use this item to enable or disable the onboard infrared port.

LPT1 Port

Use this item to enable or disable the onboard parallel port.

LPT1 Port Mode

Use this item to set the mode for the onboard parallel port. Configuration options: [Normal], [Bi-Directional], [ECP and EPP-1.9 Mode] and [ECP and EPP-1.7 Mode].

LPT1 Port Address

Use this item to set the address for the onboard parallel port. Configuration options: [Auto], [IO=378h; IRQ=5; DMA=3], [IO=378h; IRQ=5, 6, 7, 9, 10, 11, 12; DMA=1, 3] and [IO=278h; IRQ=5, 6, 7, 9, 10, 11, 12; DMA=1, 3].

3.3.5 ACPI Configuration



Suspend to RAM

Use this item to select whether to auto-detect or disable the Suspend-to-RAM feature. Select [Auto] will enable this feature if the OS supports it.

Deep S5

Mobile platforms support Deep S5 in DC only and desktop platforms support Deep S5 in AC only. The default value is [Auto].

PS/2 Keyboard Power On

Use this item to enable or disable PS/2 keyboard to turn on the system from the power-soft-off mode.

PCI Devices Power On

Use this item to enable or disable PCI devices to turn on the system from the power-soft-off mode.

Ring-In Power On

Use this item to enable or disable Ring-In signals to turn on the system from the power-soft-off mode.

RTC Alarm Power On

Use this item to enable or disable RTC (Real Time Clock) to power on the system.

USB Keyboard/Remote Power On

Use this item to enable or disable USB Keyboard/Remote to power on the system.

USB Mouse Power On

Use this item to enable or disable USB Mouse to power on the system.

3.3.6 USB Configuration



USB 2.0 Controller

Use this item to enable or disable the use of USB 2.0 controller.

USB 3.0 Controller

Use this item to enable or disable the use of USB 3.0 controller.

Legacy USB Support

Use this option to select legacy support for USB devices. There are four configuration options: [Enabled], [Auto], [Disabled] and [UEFI Setup Only]. The default value is [Enabled]. Please refer to below descriptions for the details of these four options:

[Enabled] - Enables support for legacy USB.

[Auto] - Enables legacy support if USB devices are connected.

[Disabled] - USB devices are not allowed to use under legacy OS and UEFI setup when [Disabled] is selected. If you have USB compatibility issue, it is recommended to select [Disabled] to enter OS.

[UEFI Setup Only] - USB devices are allowed to use only under UEFI setup and Windows / Linux OS.

Legacy USB 3.0 Support

Use this option to enable or disable legacy support for USB 3.0 devices.

The default value is [Disabled].

3.3.7 Voltage Configuration



DRAM Voltage

Use this to select DRAM Voltage. The default value is [Auto].

+1.05V Voltage

Use this to select +1.05V Voltage. The default value is [Auto].

+1.5V Voltage

Use this to select +1.5V Voltage. The default value is [Auto].

3.4 Hardware Health Event Monitoring Screen

In this section, it allows you to monitor the status of the hardware on your system, including the parameters of the CPU temperature, motherboard temperature, CPU fan speed, chassis fan speed, and the critical voltage.



CPU Fan Setting

This allows you to set the CPU fan speed. Configuration options: [Full On] and [Automatic Mode]. The default is value [Full On].

Chassis Fan 1 Setting

This allows you to set the chassis fan 1 speed. Configuration options: [Full On] and [Automatic Mode]. The default is value [Full On].

3.5 Boot Screen

In this section, it will display the available devices on your system for you to configure the boot settings and the boot priority.



Setup Prompt Timeout

This shows the number of seconds to wait for setup activation key. 65535(0XFFFF) means indefinite waiting.

Bootup Num-Lock

If this item is set to [On], it will automatically activate the Numeric Lock function after boot-up.

Full Screen Logo

Use this item to enable or disable OEM Logo. The default value is [Enabled].

AddOn ROM Display

Use this option to adjust AddOn ROM Display. If you enable the option "Full Screen Logo" but you want to see the AddOn ROM information when the system boots, please select [Enabled]. Configuration options: [Enabled] and [Disabled]. The default value is [Enabled].

Boot From Onboard LAN

Use this item to enable or disable the Boot From Onboard LAN feature.

Boot Failure Guard

Enable or disable the feature of Boot Failure Guard.

Boot Failure Guard Count

Enable or disable the feature of Boot Failure Guard Count.

3.6 Security Screen

In this section, you may set or change the supervisor/user password for the system. For the user password, you may also clear it.



3.7 Exit Screen



Save Changes and Exit

When you select this option, it will pop-out the following message, “Save con guration changes and exit setup?” Select [OK] to save the changes and exit the UEFI SETUP UTILITY.

Discard Changes and Exit

When you select this option, it will pop-out the following message, “Discard changes and exit setup?” Select [OK] to exit the UEFI SETUP UTILITY without saving any changes.

Discard Changes

When you select this option, it will pop-out the following message, “Discard changes?” Select [OK] to discard all changes.

Load UEFI Defaults

Load UEFI default values for all the setup questions. F9 key can be used for this operation.

Launch EFI Shell from filesystem device

Attempts to Launch EFI Shell application (Shell64.efi) from one of the available filesystem devices.

Chapter 4: Software Support

4.1 Install Operating System

This motherboard supports various Microsoft® Windows® operating systems: 7 32-bit. Because motherboard settings and hardware options vary, use the setup procedures in this chapter for general reference only. Refer to your OS documentation for more information.

4.2 Support CD Information

The Support CD that came with the motherboard contains necessary drivers and useful utilities that enhance the motherboard features.

4.2.1 Running The Support CD

To begin using the support CD, insert the CD into your CD-ROM drive. The CD automatically displays the Main Menu if "AUTORUN" is enabled in your computer. If the Main Menu did not appear automatically, locate and double click on the file "ASSETUP.EXE" from the BIN folder in the Support CD to display the menus.

4.2.2 Drivers Menu

The Drivers Menu shows the available devices drivers if the system detects installed devices. Please install the necessary drivers to activate the devices.

4.2.3 Utilities Menu

The Utilities Menu shows the applications software that the motherboard supports. Click on a specific item then follow the installation wizard to install it.

4.2.4 Contact Information

If you need to contact ASRock or want to know more about ASRock, welcome to visit ASRock's website at <http://www.asrock.com>; or you may contact your dealer for further information.