

**ASRock®**



**A68M-ITX R2.0**

User Manual

Version 1.0

Published March 2016

Copyright©2016 ASRock INC. All rights reserved.

## Copyright Notice:

No part of this documentation may be reproduced, transcribed, transmitted, or translated in any language, in any form or by any means, except duplication of documentation by the purchaser for backup purpose, without written consent of ASRock Inc.

Products and corporate names appearing in this documentation may or may not be registered trademarks or copyrights of their respective companies, and are used only for identification or explanation and to the owners' benefit, without intent to infringe.

## Disclaimer:

Specifications and information contained in this documentation are furnished for informational use only and subject to change without notice, and should not be constructed as a commitment by ASRock. ASRock assumes no responsibility for any errors or omissions that may appear in this documentation.

With respect to the contents of this documentation, ASRock does not provide warranty of any kind, either expressed or implied, including but not limited to the implied warranties or conditions of merchantability or fitness for a particular purpose.

In no event shall ASRock, its directors, officers, employees, or agents be liable for any indirect, special, incidental, or consequential damages (including damages for loss of profits, loss of business, loss of data, interruption of business and the like), even if ASRock has been advised of the possibility of such damages arising from any defect or error in the documentation or product.



This device complies with Part 15 of the FCC Rules. Operation is subject to the following two conditions:

- (1) this device may not cause harmful interference, and
- (2) this device must accept any interference received, including interference that may cause undesired operation.

## CALIFORNIA, USA ONLY

The Lithium battery adopted on this motherboard contains Perchlorate, a toxic substance controlled in Perchlorate Best Management Practices (BMP) regulations passed by the California Legislature. When you discard the Lithium battery in California, USA, please follow the related regulations in advance.

“Perchlorate Material-special handling may apply, see [www.dtsc.ca.gov/hazardouswaste/perchlorate](http://www.dtsc.ca.gov/hazardouswaste/perchlorate)”

**ASRock Website: <http://www.asrock.com>**

## AUSTRALIA ONLY

Our goods come with guarantees that cannot be excluded under the Australian Consumer Law. You are entitled to a replacement or refund for a major failure and compensation for any other reasonably foreseeable loss or damage caused by our goods. You are also entitled to have the goods repaired or replaced if the goods fail to be of acceptable quality and the failure does not amount to a major failure. If you require assistance please call ASRock Tel : +886-2-28965588 ext.123 (Standard International call charges apply)

The terms HDMI™ and HDMI High-Definition Multimedia Interface, and the HDMI logo are trademarks or registered trademarks of HDMI Licensing LLC in the United States and other countries.



# Contents

<b>1. Introduction</b>	<b>1</b>
1.1 Package Contents	1
1.2 Specifications	2
1.3 Motherboard Layout	6
1.4 I/O Panel	8
<b>2. Installation</b>	<b>10</b>
2.1 CPU Installation	11
2.2 Installation of CPU Fan and Heatsink	12
2.3 Installation of Memory Modules (DIMM)	13
2.4 Expansion Slot (PCI Express Slot)	15
2.5 Jumpers Setup	16
2.6 Onboard Headers and Connectors	17
2.7 AMD Dual Graphics Operation Guide	21
<b>3. Software and Utilities Operation</b>	<b>23</b>
3.1 Installing Drivers	23
3.2 ASRock Live Update & APP Shop	24
<b>4. UEFI SETUP UTILITY</b>	<b>30</b>
4.1 Introduction	30
4.1.1 UEFI Menu Bar	30
4.1.2 Navigation Keys	31
4.2 Main Screen	31
4.3 OC Tweaker Screen	32

4.4	Advanced Screen	35
4.4.1	CPU Configuration	36
4.4.2	North Bridge Configuration	37
4.4.3	South Bridge Configuration	38
4.4.4	Storage Configuration	39
4.4.5	ACPI Configuration	40
4.4.6	USB Configuration	42
4.5	Tool	43
4.6	Hardware Health Event Monitoring Screen	45
4.7	Boot Screen	46
4.8	Security Screen	48
4.9	Exit Screen	49

# 1. Introduction

Thank you for purchasing ASRock **A68M-ITX R2.0** motherboard, a reliable motherboard produced under ASRock's consistently stringent quality control. It delivers excellent performance with robust design conforming to ASRock's commitment to quality and endurance.

In this documentation, Chapter 1 and 2 contains the introduction of the motherboard and step-by-step installation guides. Chapter 3 contains the operation guide of the software and utilities. Chapter 4 contains the configuration guide of the BIOS setup.



Because the motherboard specifications and the BIOS software might be updated, the content of this manual will be subject to change without notice. In case any modifications of this manual occur, the updated version will be available on ASRock website without further notice. You may find the latest VGA cards and CPU support lists on ASRock website as well. ASRock website <http://www.asrock.com>

If you require technical support related to this motherboard, please visit our website for specific information about the model you are using.

[www.asrock.com/support/index.asp](http://www.asrock.com/support/index.asp)

## 1.1 Package Contents

ASRock **A68M-ITX R2.0** Motherboard (Mini-ITX Form Factor)

ASRock **A68M-ITX R2.0** Quick Installation Guide

ASRock **A68M-ITX R2.0** Support CD

2 x Serial ATA (SATA) Data Cables (Optional)

1 x I/O Panel Shield

## 1.2 Specifications

- Platform**
- Mini-ITX Form Factor
  - Solid Capacitor design

- CPU**
- Supports Socket FM2+ 95W / FM2 100W processors
  - Digi Power design

- Chipset**
- AMD A68H (Bolton-D2H)

- Memory**
- Dual Channel DDR3 Memory Technology
  - 2 x DDR3 DIMM Slots
  - Supports DDR3 2400+(OC)/2133/1866/1600/1333/1066 non-ECC, un-buffered memory (**see CAUTION 1**)
  - Max. capacity of system memory: 32GB (**see CAUTION 2**)
  - Supports Intel® Extreme Memory Profile (XMP) 1.3 / 1.2
  - Supports AMD Memory Profile (AMP) up to AMP 2400

- Expansion Slot**
- 1 x PCI Express 3.0 x16 Slot (PCIE1: x16 mode)  
\* PCIE 3.0 is only supported with FM2+ CPU. With FM2 CPU, it only supports PCIE 2.0.
  - Supports AMD Dual Graphics

- Graphics**
- Integrated AMD Radeon™ R7/R5 Series Graphics in A-series APU
  - DirectX 11.1, Pixel Shader 5.0 with FM2+ CPU. DirectX 11, Pixel Shader 5.0 with FM2 CPU.
  - Max. shared memory 2GB
  - Three graphics output options: D-Sub, DVI-D and HDMI
  - Supports Triple Monitor
  - Supports HDMI with max. resolution up to 4K × 2K (4096x2160) @ 24Hz  
\* Only FM2+ APU can support up to 4096x2160 resolution display via HDMI port
  - Supports Dual-link DVI-D with max. resolution up to 2560x1600 @ 60Hz
  - Supports D-Sub with max. resolution up to 1920x1200 @ 60Hz

- Supports Auto Lip Sync, Deep Color (12bpc), xvYCC and HBR (High Bit Rate Audio) with HDMI Port (Compliant HDMI monitor is required)
- Supports Blu-ray Stereoscopic 3D with HDMI Port
- Supports AMD Steady Video™ 2.0: New video post processing capability for automatic jitter reduction on home/online video
- Supports HDCP with DVI-D and HDMI Ports
- Supports Full HD 1080p Blu-ray (BD) playback with DVI-D and HDMI Ports

### Audio

- 7.1 CH HD Audio (Realtek ALC887 Audio Codec)
  - \* To configure 7.1 CH HD Audio, it is required to use an HD front panel audio module and enable the multi-channel audio feature through the audio driver.
- Supports Surge Protection (ASRock Full Spike Protection)
- ELNA Audio Caps

### LAN

- PCIE x1 Gigabit LAN 10/100/1000 Mb/s
- Realtek RTL8111GR
- Supports Wake-On-WAN
- Supports Wake-On-LAN
- Supports Lightning/ESD Protection (ASRock Full Spike Protection)
- Supports LAN Cable Detection
- Supports Energy Efficient Ethernet 802.3az
- Supports PXE

### Rear Panel I/O

- 1 x PS/2 Mouse/Keyboard Port
- 1 x D-Sub Port
- 1 x DVI-D Port
- 1 x HDMI Port
- 2 x USB 3.0 Ports (Supports ESD Protection (ASRock Full Spike Protection))
- 4 x USB 2.0 Ports (Supports ESD Protection (ASRock Full Spike Protection))
- 1 x RJ-45 LAN Port with LED (ACT/LINK LED and SPEED LED)
- HD Audio Jacks: Line in / Front Speaker / Microphone



- Storage**
- 4 x SATA3 6.0 Gb/s Connectors, support RAID (RAID 0, RAID 1 and RAID 10), NCQ, AHCI and Hot Plug

- Connector**
- 1 x Chassis Intrusion Header
  - 1 x CPU Fan Connector (4-pin)
  - 1 x Chassis Fan Connector (4-pin)
- \* CPU\_FAN1 and CHA\_FAN1 can auto detect if 3-pin or 4-pin fan is in use.
- 1 x 24 pin ATX Power Connector
  - 1 x 8 pin 12V Power Connector
  - 1 x Front Panel Audio Connector
  - 2 x USB 2.0 Headers (Support 4 USB 2.0 ports) (Supports ESD Protection (ASRock Full Spike Protection))
  - 1 x USB 3.0 Header by ASMedia ASM1042A (Supports 2 USB 3.0 ports) (Supports ESD Protection (ASRock Full Spike Protection))

- BIOS Feature**
- AMI UEFI Legal BIOS with GUI support
  - Supports “Plug and Play”
  - ACPI 1.1 Compliant wake up events
  - Supports jumperfree
  - SMBIOS 2.3.1 support
  - DRAM, VDDP, SB Voltage multi-adjustment

- Hardware Monitor**
- CPU/Chassis temperature sensing
  - CPU/Chassis Tachometer
  - CPU/Chassis Quiet Fan
  - CPU/Chassis Fan multi-speed control
  - CASE OPEN detection
  - Voltage monitoring: +12V, +5V, +3.3V, Vcore

- OS**
- Microsoft® Windows® 10 32-bit / 10 64-bit / 8.1 32-bit / 8.1 64-bit / 7 32-bit / 7 64-bit
- \* For the updated Windows® 10 driver, please visit ASRock's website for details: <http://www.asrock.com>
- \* Carrizo FM2r2 processor supports Windows® 10 64-bit/ 8.1 64-bit / 7 32-bit / 7 64-bit only.

**Certifications**

- FCC, CE, WHQL
- ErP/EuP Ready (ErP/EuP ready power supply is required)

\* For detailed product information, please visit our website: <http://www.asrock.com>

**WARNING**

Please realize that there is a certain risk involved with overclocking, including adjusting the setting in the BIOS, applying Untied Overclocking Technology, or using third-party overclocking tools. Overclocking may affect your system's stability, or even cause damage to the components and devices of your system. It should be done at your own risk and expense. We are not responsible for possible damage caused by overclocking.

**CAUTION!**

1. Whether 2400/2133/1866/1600MHz memory speed is supported depends on the CPU you adopt. If you want to adopt DDR3 2400/2133/1866/1600 memory module on this motherboard, please refer to the memory support list on our website for the compatible memory modules.  
ASRock website <http://www.asrock.com>
2. Due to the operating system limitation, the actual memory size may be less than 4GB for the reservation for system usage under Windows® 10 / 8.1 / 7. For Windows® 64-bit OS with 64-bit CPU, there is no such limitation.

### 1.3 Motherboard Layout

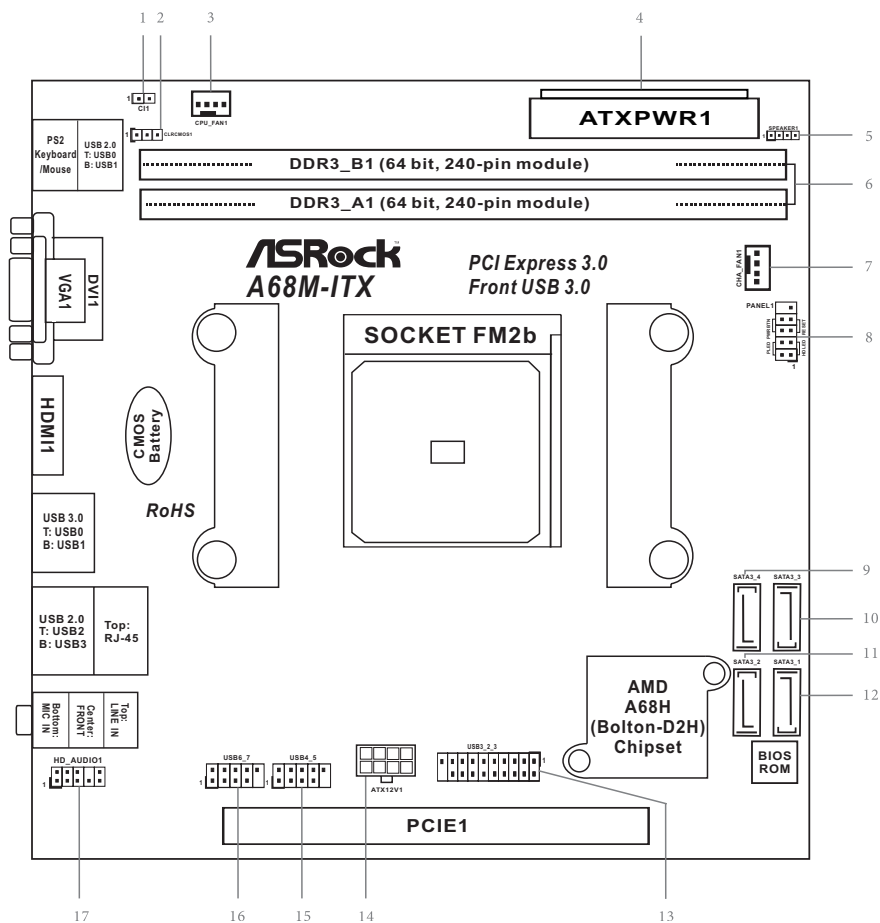

No.	Description
1	Chassis Intrusion Header (CI1)
2	Clear CMOS Jumper (CLRCMOS1)
3	CPU Fan Connector (CPU_FAN1)
4	ATX Power Connector (ATXPWR1)
5	Chassis Speaker Header (SPEAKER1)
6	2 x 240-pin DDR3 DIMM Slots (DDR3_A1, DDR3_B1)
7	Chassis Fan Connector (CHA_FAN1)
8	System Panel Header (PANEL1)
9	SATA3 Connector (SATA3_4)
10	SATA3 Connector (SATA3_3)
11	SATA3 Connector (SATA3_2)
12	SATA3 Connector (SATA3_1)
13	USB 3.0 Header (USB3_2_3)
14	ATX 12V Power Connector (ATX12V1)
15	USB 2.0 Header (USB4_5)
16	USB 2.0 Header (USB6_7)
17	Front Panel Audio Header (HD_AUDIO1)

## 1.4 I/O Panel

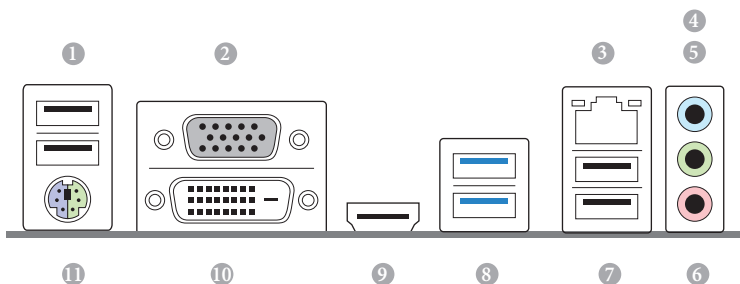

No.	Description	No.	Description
1	USB 2.0 Ports (USB01)*	7	USB 2.0 Ports (USB23)*
2	D-Sub Port	8	USB 3.0 Ports (USB3_01)
3	LAN RJ-45 Port**	9	HDMI Port
4	Line In (Light Blue)	10	DVI-D Port
5	Front Speaker (Lime)***	11	PS/2 Mouse/Keyboard Port
6	Microphone (Pink)		

\* It is recommended to install the USB Keyboard/Mouse cable to USB 2.0 ports (USB01 or USB23) instead of USB 3.0 ports.

\*\* There are two LEDs on the LAN port. Please refer to the table below for the LAN port LED indications.

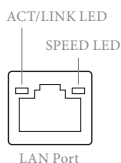

Activity / Link LED		Speed LED	
Status	Description	Status	Description
Off	No Link	Off	10Mbps connection
Blinking	Data Activity	Orange	100Mbps connection
On	Link	Green	1Gbps connection

\*\*\* To configure 7.1 CH HD Audio, it is required to use an HD front panel audio module and enable the multi-channel audio feature through the audio driver.

Please set Speaker Configuration to "7.1 Speaker" in the Realtek HD Audio Manager.

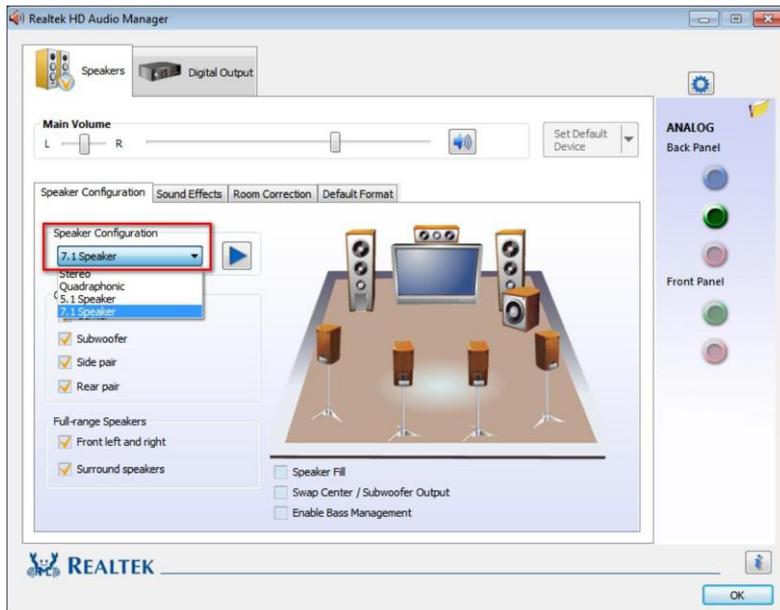

***Function of the Audio Ports in 7.1-channel Configuration:***

Port	Function
Light Blue (Rear panel)	Rear Speaker Out
Lime (Rear panel)	Front Speaker Out
Pink (Rear panel)	Central /Subwoofer Speaker Out
Lime (Front panel)	Side Speaker Out

## 2. Installation

This is a Mini-ITX form factor motherboard. Before you install the motherboard, study the configuration of your chassis to ensure that the motherboard fits into it.

### Pre-installation Precautions

Take note of the following precautions before you install motherboard components or change any motherboard settings.



Before you install or remove any component, ensure that the power is switched off or the power cord is detached from the power supply. Failure to do so may cause severe damage to the motherboard, peripherals, and/or components.

1. Unplug the power cord from the wall socket before touching any component.
2. To avoid damaging the motherboard components due to static electricity, NEVER place your motherboard directly on the carpet or the like. Also remember to use a grounded wrist strap or touch a safety grounded object before you handle components.
3. Hold components by the edges and do not touch the ICs.
4. Whenever you uninstall any component, place it on a grounded anti-static pad or in the bag that comes with the component.
5. When placing screws into the screw holes to secure the motherboard to the chassis, please do not over-tighten the screws! Doing so may damage the motherboard.

## 2.1 CPU Installation

Step 1. Unlock the socket by lifting the lever up to a 90° angle.

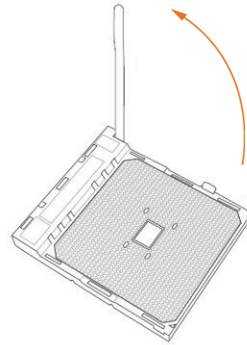

Step 2. Position the CPU directly above the socket such that the CPU corner with the golden triangle matches the socket corner with a small triangle.

Step 3. Carefully insert the CPU into the socket until it fits in place.



The CPU fits only in one correct orientation. DO NOT force the CPU into the socket to avoid bending of the pins.

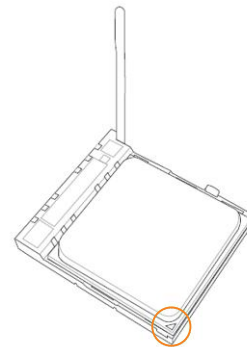

Step 4. When the CPU is in place, press it firmly on the socket while you push down the socket lever to secure the CPU. The lever clicks on the side tab to indicate that it is locked.





## 2.2 Installation of CPU Fan and Heatsink

After you install the CPU into this motherboard, it is necessary to install a larger heatsink and cooling fan to dissipate heat. You also need to spray thermal grease between the CPU and the heatsink to improve heat dissipation. Make sure that the CPU and the heatsink are securely fastened and in good contact with each other. Then connect the CPU fan to the CPU FAN connector (CPU\_FAN1, see Page 6, No. 3). For proper installation, please kindly refer to the instruction manuals of the CPU fan and the heatsink.

## 2.3 Installation of Memory Modules (DIMM)

This motherboard provides two 240-pin DDR3 (Double Data Rate 3) DIMM slots, and supports Dual Channel Memory Technology.



- 1. For dual channel configuration, you always need to install identical (the same brand, speed, size and chip-type) DDR3 DIMM pairs.*
- 2. It is unable to activate Dual Channel Memory Technology with only one memory module installed.*
- 3. It is not allowed to install a DDR or DDR2 memory module into a DDR3 slot; otherwise, this motherboard and DIMM may be damaged.*



*The DIMM only fits in one correct orientation. It will cause permanent damage to the motherboard and the DIMM if you force the DIMM into the slot at incorrect orientation.*

1

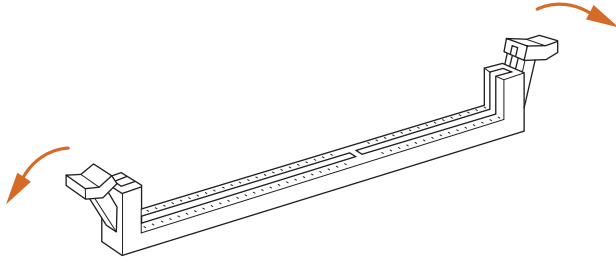

2

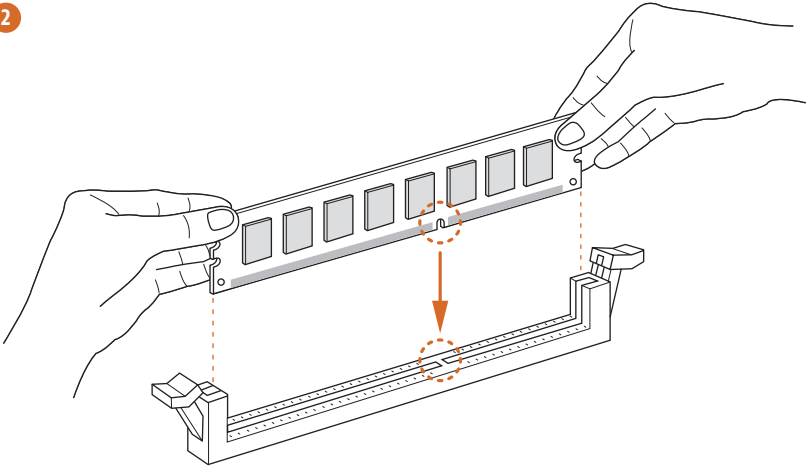

3

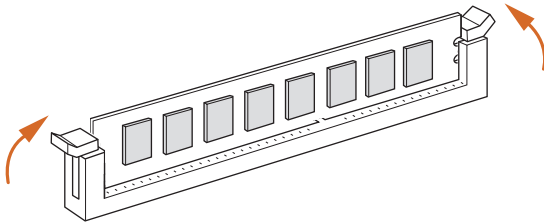

## 2.4 Expansion Slot (PCI Express Slot)

There is 1 PCI Express slot on this motherboard.





*Before installing an expansion card, please make sure that the power supply is switched off or the power cord is unplugged. Please read the documentation of the expansion card and make necessary hardware settings for the card before you start the installation.*

**PCIe Slot:** PCIe1 (PCIe 3.0 x16 slot) is used for PCI Express x16 lane width graphics cards.

## 2.5 Jumpers Setup

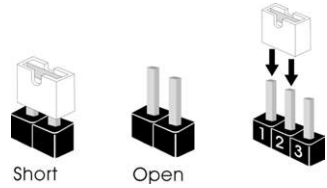
The illustration shows how jumpers are setup. When the jumper cap is placed on pins, the jumper is “Short”. If no jumper cap is placed on pins, the jumper is “Open”. The illustration shows a 3-pin jumper whose pin1 and pin2 are “Short” when jumper cap is placed on these 2 pins.



Jumper	Setting	Description
Clear CMOS Jumper (CLRCMOS1) (see p.6, No. 2)	<b>1_2</b>  Default	<b>2_3</b>  Clear CMOS

Note: CLRCMOS1 allows you to clear the data in CMOS. To clear and reset the system parameters to default setup, please turn off the computer and unplug the power cord from the power supply. After waiting for 15 seconds, use a jumper cap to short pin2 and pin3 on CLRCMOS1 for 5 seconds. However, please do not clear the CMOS right after you update the BIOS. If you need to clear the CMOS when you just finish updating the BIOS, you must boot up the system first, and then shut it down before you do the clear-CMOS action. Please be noted that the password, date, time, user default profile, 1394 GUID and MAC address will be cleared only if the CMOS battery is removed.



If you clear the CMOS, the case open may be detected. Please adjust the BIOS option “Clear Status” to clear the record of previous chassis intrusion status.

## 2.6 Onboard Headers and Connectors



Onboard headers and connectors are NOT jumpers. Do NOT place jumper caps over these headers and connectors. Placing jumper caps over the headers and connectors will cause permanent damage of the motherboard!

### Serial ATA3 Connectors

(SATA3\_1: see p.6, No. 12)

(SATA3\_2: see p.6, No. 11)

(SATA3\_3: see p.6, No. 10)

(SATA3\_4: see p.6, No. 9)



These four Serial ATA3 (SATA3) connectors support SATA data cables for internal storage devices. The current SATA3 interface allows up to 6.0 Gb/s data transfer rate.

### USB 2.0 Headers

(9-pin USB4\_5)

(see p.6 No. 15)

(9-pin USB6\_7)

(see p.6 No. 16)

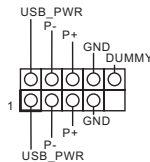

Besides two default USB 2.0 ports on the I/O panel, there are two USB 2.0 headers on this motherboard. Each USB 2.0 header can support two USB 2.0 ports.

### USB 3.0 Header

(19-pin USB3\_2\_3)

(see p.6 No. 13)

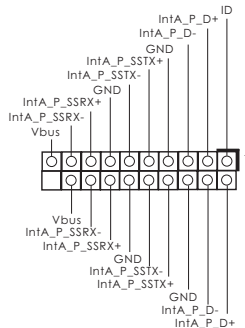

Besides four default USB 3.0 ports on the I/O panel, there is one USB 3.0 header on this motherboard. This USB 3.0 header can support two USB 3.0 ports.

## Front Panel Audio Header

(9-pin HD\_AUDIO1)

(see p.6 No. 17)

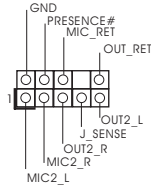

This is an interface for the front panel audio cable that allows convenient connection and control of audio devices.



1. High Definition Audio supports Jack Sensing, but the panel wire on the chassis must support HDA to function correctly. Please follow the instruction in our manual and chassis manual to install your system.
2. If you use AC'97 audio panel, please install it to the front panel audio header as below:
  - A. Connect Mic\_IN (MIC) to MIC2\_L.
  - B. Connect Audio\_R (RIN) to OUT2\_R and Audio\_L (LIN) to OUT2\_L.
  - C. Connect Ground (GND) to Ground (GND).
  - D. MIC\_RET and OUT\_RET are for HD audio panel only. You don't need to connect them for AC'97 audio panel.
  - E. To activate the front mic.  
For Windows® 10 / 10 64-bit / 8.1 / 8.1 64-bit / 7 / 7 64-bit OS:  
Go to the "FrontMic" Tab in the Realtek Control panel. Adjust "Recording Volume".

## System Panel Header

(9-pin PANEL1)

(see p.6 No. 8)

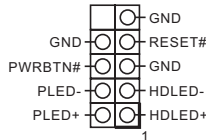

This header accommodates several system front panel functions.



Connect the power switch, reset switch and system status indicator on the chassis to this header according to the pin assignments below. Note the positive and negative pins before connecting the cables.

### **PWRBTN (Power Switch):**

Connect to the power switch on the chassis front panel. You may configure the way to turn off your system using the power switch.

### **RESET (Reset Switch):**

Connect to the reset switch on the chassis front panel. Press the reset switch to restart the computer if the computer freezes and fails to perform a normal restart.

**PLED (System Power LED):**

Connect to the power status indicator on the chassis front panel. The LED is on when the system is operating. The LED keeps blinking when the system is in S3 sleep state. The LED is off when the system is in S4 sleep state or powered off (S5).

**HDLED (Hard Drive Activity LED):**

Connect to the hard drive activity LED on the chassis front panel. The LED is on when the hard drive is reading or writing data.

The front panel design may differ by chassis. A front panel module mainly consists of power switch, reset switch, power LED, hard drive activity LED, speaker and etc. When connecting your chassis front panel module to this header, make sure the wire assignments and the pin assignments are matched correctly.

**Chassis Speaker Header**

(4-pin SPEAKER 1)  
(see p.6 No. 5)

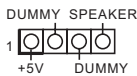

Please connect the chassis speaker to this header.

**Chassis Fan Connector**

(4-pin CHA\_FAN1)  
(see p.6 No. 7)

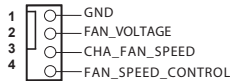

Please connect the fan cable to the fan connector and match the black wire to the ground pin.

**CPU Fan Connector**

(4-pin CPU\_FAN1)  
(see p.6 No. 3)

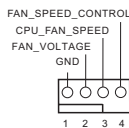

Please connect the CPU fan cable to the connector and match the black wire to the ground pin.



Though this motherboard provides 4-Pin CPU fan (Quiet Fan) support, the 3-Pin CPU fan still can work successfully even without the fan speed control function. If you plan to connect the 3-Pin CPU fan to the CPU fan connector on this motherboard, please connect it to Pin 1-3.

Pin 1-3 Connected ←

3-Pin Fan Installation





### ATX Power Connector

(24-pin ATXPWR1)

(see p.6 No. 4)

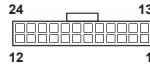

Please connect an ATX power supply to this connector.



Though this motherboard provides 24-pin ATX power connector, it can still work if you adopt a traditional 20-pin ATX power supply. To use the 20-pin ATX power supply, please plug your power supply along with Pin 1 and Pin 13.

20-Pin ATX Power Supply Installation

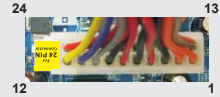

### ATX 12V Power Connector

(8-pin ATX12V1)

(see p.6 No. 14)

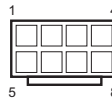

Please connect an ATX 12V power supply to this connector.



Though this motherboard provides 8-pin ATX 12V power connector, it can still work if you adopt a traditional 4-pin ATX 12V power supply. To use the 4-pin ATX power supply, please plug your power supply along with Pin 1 and Pin 5.

4-Pin ATX 12V Power Supply Installation

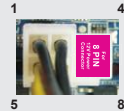

### Chassis Intrusion Header

(2-pin Cl1)

(see p.6 No. 1)



This motherboard supports CASE OPEN detection feature that detects if the chassis cover has been removed. This feature requires a chassis with chassis intrusion detection design.

## 2.7 AMD Dual Graphics Operation Guide

This motherboard supports AMD Dual Graphics feature. AMD Dual Graphics brings multi-GPU performance capabilities by enabling an AMD A68H (Bolton-D2H) integrated graphics processor and a discrete graphics processor to operate simultaneously with combined output to a single display for blisteringly-fast frame rates. Currently, AMD Dual Graphics Technology is only supported with Windows® 10 / 8.1 / 7 OS.



### What does an AMD Dual Graphics system include?

An AMD Dual Graphics system includes an AMD Radeon™ R7/R5 Series graphics processor and a motherboard based on an AMD A68H (Bolton-D2H) integrated chipset, all operating in a Windows® 10 / 8.1 / 7 environment. Please refer to AMD website for further information.

## Enjoy the benefit of AMD Dual Graphics

- Step 1. Please keep the default UEFI setting of “Dual Graphics” option on [Auto].
- Step 2. Install one AMD RADEON PCI Express graphics card to PCIE1 slot.
- Step 3. Connect the monitor cable to the onboard VGA port. Please be noted that the current VGA driver / VBIOS can allow Dual Graphics output from onboard display only. For any future update, please refer to our website for further information.
- Step 4. Boot into OS. Please remove the AMD driver if you have any VGA driver installed in your system.
- Step 5. Install the onboard VGA driver from our support CD to your system for both the onboard VGA and the discrete graphics card.
- Step 6. Restart your computer. Right-click the desktop. Click “AMD VISION Engine Control Center” to enter AMD VISION Engine Control Center.



Step 7. You can also click “AMD VISION Engine Control Center” on your Windows® taskbar to enter AMD VISION Engine Control Center.

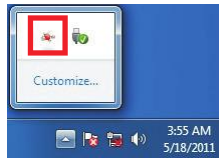

AMD VISION Engine Control Center

Step 8. In AMD VISION Engine Control Center, please choose “Performance”. Click “AMD CrossFire™”.

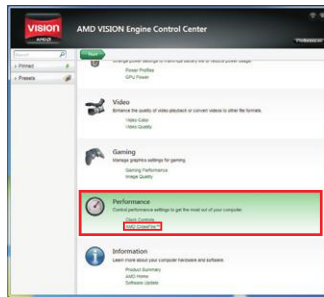

Step 9. Click “Enable CrossFire™” and click “Apply” to save your change.

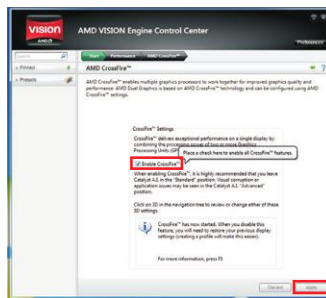

Step 10. Reboot your system. Then you can freely enjoy the benefit of Dual Graphics feature.

- \* Dual Graphics appearing here is a registered trademark of AMD Technologies Inc., and is used only for identification or explanation and to the owners' benefit, without intent to infringe.
- \* For further information of AMD Dual Graphics technology, please check AMD website for up dates and details.

## 3. *Software and Utilities Operation*

### 3.1 Installing Drivers

The Support CD that comes with the motherboard contains necessary drivers and useful utilities that enhance the motherboard's features.

#### Running The Support CD

To begin using the support CD, insert the CD into your CD-ROM drive. The CD automatically displays the Main Menu if "AUTORUN" is enabled in your computer. If the Main Menu does not appear automatically, locate and double click on the file "ASRSETUP.EXE" in the Support CD to display the menu.

#### Drivers Menu

The drivers compatible to your system will be auto-detected and listed on the support CD driver page. Please click Install All or follow the order from top to bottom to install those required drivers. Therefore, the drivers you install can work properly.

#### Utilities Menu

The Utilities Menu shows the application software that the motherboard supports. Click on a specific item then follow the installation wizard to install it.

## 3.2 ASRock Live Update & APP Shop

The ASRock Live Update & APP Shop is an online store for purchasing and downloading software applications for your ASRock computer. You can install various apps and support utilities quickly and easily, and optimize your system and keep your motherboard up to date simply with a few clicks.

Double-click  on your desktop to access ASRock Live Update & APP Shop utility.

*\*You need to be connected to the Internet to download apps from the ASRock Live Update & APP Shop.*

### 3.2.1 UI Overview

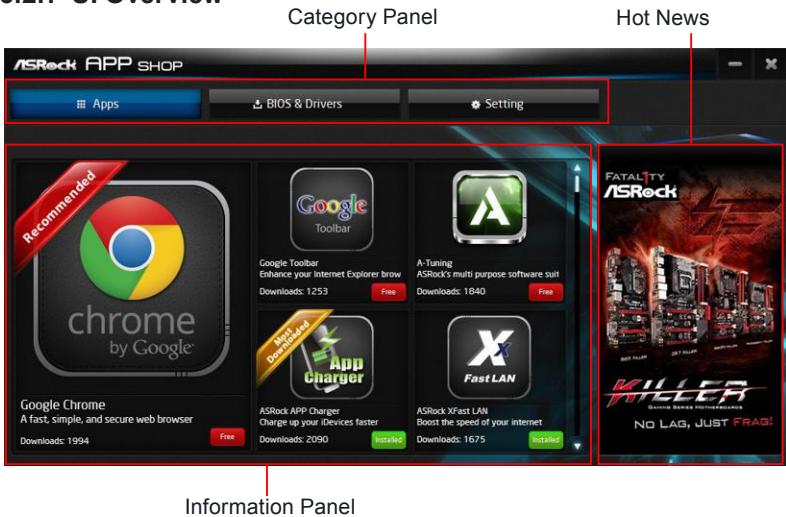

**Category Panel:** The category panel contains several category tabs or buttons that when selected the information panel below displays the relative information.

**Information Panel:** The information panel in the center displays data about the currently selected category and allows users to perform job-related tasks.

**Hot News:** The hot news section displays the various latest news. Click on the image to visit the website of the selected news and know more.

## 3.2.2 Apps

When the "Apps" tab is selected, you will see all the available apps on screen for you to download.

### Installing an App

#### Step 1

Find the app you want to install.



The most recommended app appears on the left side of the screen. The other various apps are shown on the right. Please scroll up and down to see more apps listed.

You can check the price of the app and whether you have already installed it or not.

**Free** - The red icon displays the price or "Free" if the app is free of charge.

**Installed** - The green "Installed" icon means the app is installed on your computer.

#### Step 2

Click on the app icon to see more details about the selected app.

### **Step 3**

If you want to install the app, click on the red icon  to start downloading.

### **Step 4**

When installation completes, you can find the green "Installed" icon appears on the upper right corner.

To uninstall it, simply click on the trash can icon  .  
\*The trash icon may not appear for certain apps.

## Upgrading an App

You can only upgrade the apps you have already installed. When there is an available new version for your app, you will find the mark of "New Version" appears below the installed app icon.



### Step 1

Click on the app icon to see more details.

### Step 2

Click on the yellow icon to start upgrading.



### 3.2.3 BIOS & Drivers

#### Installing BIOS or Drivers

When the "BIOS & Drivers" tab is selected, you will see a list of recommended or critical updates for the BIOS or drivers. Please update them all soon.

##### **Step 1**

Please check the item information before update. Click on  to see more details.

##### **Step 2**

Click to select one or more items you want to update.

##### **Step 3**

Click Update to start the update process.

### 3.2.4 Setting

In the "Setting" page, you can change the language, select the server location, and determine if you want to automatically run the ASRock Live Update & APP Shop on Windows startup.

## 4. UEFI SETUP UTILITY

### 4.1 Introduction

ASRock Interactive UEFI is a blend of system configuration tools, cool sound effects and stunning visuals. Not only will it make BIOS setup less difficult but also a lot more amusing. This section explains how to use the UEFI SETUP UTILITY to configure your system. The UEFI chip on the motherboard stores the UEFI SETUP UTILITY. You may run the UEFI SETUP UTILITY when you start up the computer. Please press <F2> or <Delete> during the Power-On-Self-Test (POST) to enter the UEFI SETUP UTILITY, otherwise, POST will continue with its test routines.

If you wish to enter the UEFI SETUP UTILITY after POST, restart the system by pressing <Ctl> + <Alt> + <Delete>, or by pressing the reset button on the system chassis. You may also restart by turning the system off and then back on.



Because the UEFI software is constantly being updated, the following UEFI setup screens and descriptions are for reference purpose only, and they may not exactly match what you see on your screen.

#### 4.1.1 UEFI Menu Bar

The top of the screen has a menu bar with the following selections:

<b>Main</b>	For setting system time/date information
<b>OC Tweaker</b>	For overclocking configurations
<b>Advanced</b>	For advanced system configurations
<b>Tool</b>	Useful tools
<b>H/W Monitor</b>	Displays current hardware status
<b>Boot</b>	For configuring boot settings and boot priority
<b>Security</b>	For security settings
<b>Exit</b>	Exit the current screen or the UEFI SETUP UTILITY

Use < > key or < > key to choose among the selections on the menu bar, and use < > key or < > key to move the cursor up or down to select items, then press <Enter> to get into the sub screen. You can also navigate with a mouse.

## 4.1.2 Navigation Keys

Please check the following table for the function description of each navigation key.

<b>Navigation Key(s)</b>	<b>Function Description</b>
/	Moves cursor left or right to select Screens
/	Moves cursor up or down to select items
+ / -	To change option for the selected items
<Tab>	Switch to next function
<Enter>	To bring up the selected screen
<PGUP>	Go to the previous page
<PGDN>	Go to the next page
<HOME>	Go to the top of the screen
<END>	Go to the bottom of the screen
<F1>	To display the General Help Screen
<F7>	Discard changes and exit the UEFI SETUP UTILITY
<F9>	Load optimal default values for all the settings
<F10>	Save changes and exit the UEFI SETUP UTILITY
<F12>	Print screen
<ESC>	Jump to the Exit Screen or exit the current screen

## 4.2 Main Screen

When you enter the UEFI SETUP UTILITY, the Main screen will appear and display the system overview.

### Active Page on Entry

This allows you to select the default page when entering UEFI setup utility.

## 4.3 OC Tweaker Screen

In the OC Tweaker screen, you can set up overclocking features.

### **EZ OC Mode**

You can use this option to adjust EZ overclocking setting. Please note that overclocking may cause damage to your components and motherboard. It should be done at your own risk and expense.

### **CPU Configuration**

#### **Overclock Mode**

Use this to select Overclock Mode. Configuration options: [Auto] and [Manual]. The default value is [Auto].

#### **APU/PCIE Frequency (MHz)**

This item appears only when you set the item "Overclock Mode" to [Manual]. The default value is [Disabled]. Please be noted that overclocking may reduce the D-Sub resolution and cause the display abnormal situation. It is recommended to use DVI or HDMI monitor to get better performance.

#### **Spread Spectrum**

This item should always be [Auto] for better system stability.

#### **AMD Turbo Core Technology**

This item appears only when the processor you adopt supports this feature. Use this to select enable or disable AMD Turbo Core Technology. Configuration options: [Enabled] and [Disabled]. The default value is [Enabled].

#### **AMD Application power Management**

Application Power Management (APM) ensures that average power consumption over a thermally significant time period remains at or below the TDP for the CPU mode being used. If [Enabled] is selected, the power consumption is reduced when overclocking.

**Processor Maximum Frequency**

It will display Processor Maximum Frequency for reference.

**Processor Maximum Voltage**

It will display Processor Maximum Voltage for reference.

**Multiplier/Voltage Change**

This item is set to [Auto] by default. If it is set to [Manual], you may adjust the value of Processor Frequency and Processor Voltage. However, it is recommended to keep the default value for system stability.

**Boost Frequency Multiplier**

For safety and system stability, it is not recommended to adjust the value of this item.

**CPU Frequency Multiplier**

For safety and system stability, it is not recommended to adjust the value of this item.

**Voltage Control Mode**

Use this to control voltage mode.

**CPU Voltage**

It allows you to adjust the value of CPU voltage. However, for safety and system stability, it is not recommended to adjust the value of this item.

**CPU Voltage Offset**

It allows you to adjust the value of CPU voltage offset. However, for safety and system stability, it is not recommended to adjust the value of this item.

**CPU NB Frequency Multiplier**

For safety and system stability, it is not recommended to adjust the value of this item.

**APU Load-line Calibration**

APU Load-line Calibration helps prevent APU voltage droop when the system is under heavy load.

**GFX Engine Clock**

Use this to adjust GFX Engine Clock. The default value is [Auto].

**DRAM Timing Configuration****DRAM Frequency**

If [Auto] is selected, the motherboard will detect the memory module(s) inserted and assigns appropriate frequency automatically.

## **DRAM Timing Control**

### **DRAM Slot**

Use this item to view SPD data.

### **DRAM Timing Control**

Use this item to control DRAM timing.

### **Power Down Enable**

Use this item to enable or disable DDR power down mode.

### **Bank Interleaving**

Interleaving allows memory accesses to be spread out over banks on the same node, or across nodes, decreasing access contention.

### **Channel Interleaving**

It allows you to enable Channel Memory Interleaving. Configuration options: [Disabled], [Auto]. The default value is [Auto].

## **Voltage Configuration**

### **DRAM Voltage**

Use this to select DRAM Voltage. The default value is [Auto].

### **APU PCIE Voltage VDDP**

Use this to select APU PCIE Voltage VDDP. The default value is [Auto].

### **SB Voltage**

Use this to select SB Voltage. The default value is [Auto].

## 4.4 Advanced Screen

In this section, you may set the configurations for the following items: CPU Configuration, North Bridge Configuration, South Bridge Configuration, Storage Configuration, ACPI Configuration and USB Configuration.



Setting wrong values in this section may cause the system to malfunction.



## 4.4.1 CPU Configuration

### **Core C6 Mode**

Use this item to enable or disable Core C6 mode. The default value is [Enabled].

### **Package C6 Mode**

This item appears only when you enable the item "Core C6 Mode". Use this item to enable or disable Package C6 mode. The default value is [Disabled].

### **Cool 'n' Quiet**

Use this item to enable or disable AMD's Cool 'n' Quiet™ technology. The default value is [Enabled]. Configuration options: [Enabled] and [Disabled]. If you install Windows® 10 / 8.1 / 7 and want to enable this function, please set this item to [Enabled]. Please note that enabling this function may reduce CPU voltage and memory frequency, and lead to system stability or compatibility issue with some memory modules or power supplies. Please set this item to [Disable] if above issue occurs.

### **SVM**

When this option is set to [Enabled], a VMM (Virtual Machine Architecture) can utilize the additional hardware capabilities provided by AMD-V. The default value is [Enabled]. Configuration options: [Enabled] and [Disabled].

## 4.4.2 North Bridge Configuration

### **IOMMU**

This allows you to enable or disable IOMMU support.

### **Primary Graphics Adapter**

This item allows you to select the type of Primary VGA in case of multiple video controllers. The default value of this feature is [PCI Express].

### **Onboard Graphics**

Select Enable/Disable/Auto for the onboard graphics.

### **Share Memory**

This allows you to set the share memory feature. The default value is [Auto]. Configuration options: [Auto], [32MB], [64MB], [128MB], [256MB] [512MB], [1GB] and [2GB].

### **Onboard HDMI HD Audio**

This allows you to enable or disable the “Onboard HDMI HD Audio” feature.

### **DVI Function**

Use this to select DVI function when you install the DVI to HDMI adapter to DVI port. Configuration options: [as Dual Link DVI] and [as HDMI]. If you select [as Dual Link DVI], you can use Dual Link DVI monitor without audio function. If you select [as HDMI], you can use HDMI monitor with audio function. The default value is [as Dual Link DVI].

---

### 4.4.3 South Bridge Configuration

#### **Onboard HD Audio**

Select [Auto], [Enabled] or [Disabled] for the onboard HD Audio feature.

#### **Front Panel**

Select [Auto] or [Disabled] for the onboard HD Audio Front Panel.

#### **Onboard LAN**

This allows you to enable or disable the onboard LAN feature.

#### **Good Night LED**

Enable this option to turn off Power LED when the system is power on.

The keyboard LED will also be turned off in S3 and S4 state.

The default value is [Auto].

## 4.4.4 Storage Configuration

### **SATA Controller**

Use this item to enable or disable the "SATA Controller" feature.

### **SATA Mode**

Use this item to adjust SATA Mode. The default value of this option is [AHCI Mode]. Configuration options: [AHCI Mode], [RAID Mode] and [IDE Mode].

### **AMD AHCI BIOS ROM**

Use this item to enable or disable AMD AHCI BIOS ROM. The default value of this option is [Disabled].

### **Hard Disk S.M.A.R.T.**

Use this item to enable or disable the S.M.A.R.T. (Self-Monitoring, Analysis, and Reporting Technology) feature. Configuration options: [Disabled], [Auto], [Enabled].

## 4.4.5 ACPI Configuration

### **Suspend to RAM**

Use this item to select whether to auto-detect or disable the Suspend-to-RAM feature. Select [Auto] will enable this feature if the OS supports it.

### **Check Ready Bit**

Enable to enter the operating system after S3 only when the hard disk is ready, this is recommended for better system stability.

### **Deep Sleep**

Configure deep sleep mode for power saving when the computer is shut down. We recommend disabling Deep Sleep for better system compatibility and stability.

### **Restore on AC/Power Loss**

This allows you to set the power state after an unexpected AC/power loss. If [Power Off] is selected, the AC/power remains off when the power recovers. If [Power On] is selected, the AC/power resumes and the system starts to boot up when the power recovers.

### **PS/2 Keyboard Power On**

Use this item to enable or disable PS/2 keyboard to turn on the system from the power-soft-off mode.

### **PCI Devices Power On**

Use this item to enable or disable PCI devices to turn on the system from the power-soft-off mode.

### **RTC Alarm Power On**

Use this item to enable or disable RTC (Real Time Clock) to power on the system.

### **USB Keyboard/Remote Power On**

Use this item to enable or disable USB Keyboard/Remote to power on the system.

**USB Mouse Power On**

Use this item to enable or disable USB Mouse to power on the system.

**ACPI HPET table**

Use this item to enable or disable ACPI HPET Table. The default value is [Enabled]. Please set this option to [Enabled] if you plan to use this motherboard to submit Windows® certification.

## 4.4.6 USB Configuration

### **USB Controller**

Use this item to enable or disable the use of USB 2.0 controller.

### **A68 USB 3.0 Controller**

Use this item to enable or disable the use of USB 3.0 controller.

### **Legacy USB Support**

Use this option to select legacy support for USB devices. There are four configuration options: [Enabled], [Auto], [Disabled] and [UEFI Setup Only]. The default value is [Enabled]. Please refer to below descriptions for the details of these four options:

[Enabled] - Enables support for legacy USB.

[Auto] - Enables legacy support if USB devices are connected.

[Disabled] - USB devices are not allowed to use under legacy OS and UEFI setup when [Disabled] is selected. If you have USB compatibility issue, it is recommended to select [Disabled] to enter OS.

[UEFI Setup Only] - USB devices are allowed to use only under UEFI setup and Windows / Linux OS.

### **Legacy USB 3.0 Support**

Use this option to enable or disable legacy support for USB 3.0 devices. The default value is [Enabled].

## 4.5 Tool

### **System Browser**

System Browser can let you easily check your current system configuration in UEFI setup.

### **OMG(Online Management Guard)**

Administrators are able to establish an internet curfew or restrict internet access at specified times via OMG. You may schedule the starting and ending hours of internet access granted to other users. In order to prevent users from bypassing OMG, guest accounts without permission to modify the system time are required.

### **UEFI Tech Service**

Contact ASRock Tech Service if you are having trouble with your PC. Please setup network configuration before using UEFI Tech Service.

### **Easy RAID Installer**

Easy RAID Installer helps you to copy the RAID driver from the support CD to your USB storage device. After copying the drivers please change the SATA mode to RAID, then you can start installing the operating system in RAID mode.

### **Easy Driver Installer**

For users that don't have an optical disk drive to install the drivers from our support CD, Easy Driver Installer is a handy tool in the UEFI that installs the LAN driver to your system via an USB storage device, then downloads and installs the other required drivers automatically.

### **UEFI Update Utility**

#### **Instant Flash**

Instant Flash is a UEFI flash utility embedded in Flash ROM. This convenient UEFI update tool allows you to update system UEFI without entering operating systems first like MS-DOS or Windows®. Just save the new



UEFI file to your USB flash drive, floppy disk or hard drive and launch this tool, then you can update your UEFI only in a few clicks without preparing an additional floppy diskette or other complicated flash utility. Please be noted that the USB flash drive or hard drive must use FAT32/16/12 file system. If you execute Instant Flash utility, the utility will show the UEFI files and their respective information. Select the proper UEFI file to update your UEFI, and reboot your system after the UEFI update process is completed.

### **Internet Flash**

Internet Flash searches for available UEFI firmware updates from our servers. In other words, the system can auto-detect the latest UEFI from our servers and flash them without entering Windows OS.

### **Network Configuration**

### **Internet Setting**

Use this item to set up the internet connection mode. Configuration options: [DHCP (Auto IP)] and [PPPOE].

### **UEFI Download Server**

Use this item to select UEFI firmware download server for Internet Flash. Configuration options: [Asia], [Europe], [USA] and [China].

### **Would you like to save current setting user defaults?**

In this option, you are allowed to load and save three user defaults according to your own requirements.

## 4.6 Hardware Health Event Monitoring Screen

In this section, it allows you to monitor the status of the hardware on your system, including the parameters of the CPU temperature, motherboard temperature, CPU fan speed, chassis fan speed, and the critical voltage.

### **CPU Fan 1 Setting**

This allows you to set the CPU fan 1 speed. Configuration options: [Full On] and [Automatic Mode]. The default is value [Full On].

### **Chassis Fan 1 Setting**

This allows you to set the chassis fan 1 speed. Configuration options: [Full On], [Manual Mode] and [Automatic Mode]. The default is value [Full On].

### **Over Temperature Protection**

Use this item to enable or disable Over Temperature Protection. The default value is [Enabled].

### **Case Open Feature**

This allows you to enable or disable case open detection feature. The default is value [Disabled].

### **Clear Status**

This option appears only when the case open has been detected. Use this option to keep or clear the record of previous chassis intrusion status.

## 4.7 Boot Screen

In this section, it will display the available devices on your system for you to configure the boot settings and the boot priority.

### Fast Boot

Fast Boot minimizes your computer's boot time. There are three configuration options: [Disabled], [Fast] and [Ultra Fast]. The default value is [Disabled]. Please refer to below descriptions for the details of these three options:

[Disabled] - Disable Fast Boot.

[Fast] - The only restriction is you may not boot by using an USB flash drive.

[Ultra Fast] - There are a few restrictions.

1. Only supports Windows® 8.1 UEFI operating system.
2. You will not be able to enter BIOS Setup (Clear CMOS or run utility in Windows® to enter BIOS Setup).
3. If you are using an external graphics card, the VBIOS must support UEFI GOP in order to boot.

### Setup Prompt Timeout

This shows the number of seconds to wait for setup activation key.

### Startup Num-Lock

If this item is set to [On], it will automatically activate the Numeric Lock function after boot-up.

### Full Screen Logo

Use this item to enable or disable OEM Logo. The default value is [Enabled].

### AddOn ROM Display

[Force BIOS] - The third-party ROM messages will be forced to display during the bootsequence.

[Keep Current] - The third-party ROM messages will be displayed only if the third-party manufacturer had set the add-on device to do so.

**Boot Failure Guard**

Enable or disable the feature of Boot Failure Guard.

**Boot Failure Guard Count**

Enable or disable the feature of Boot Failure Guard Count.

**CSM (Compatibility Support Module)****CSM**

Enable to launch the Compatibility Support Module. Please do not disable unless you're running a WHCK test. If you are using Windows® 8.1 64-bit and all of your devices support UEFI, you may also disable CSM for faster boot speed.

**Launch PXE OpROM Policy**

Select UEFI only to run those that support UEFI option ROM only. Select Legacy only to run those that support legacy option ROM only. Do not launch?

**Launch Storage OpROM Policy**

Select UEFI only to run those that support UEFI option ROM only. Select Legacy only to run those that support legacy option ROM only. Do not launch?

**Launch Video OpROM Policy**

Select UEFI only to run those that support UEFI option ROM only. Select Legacy only to run those that support legacy option ROM only. Do not launch?

---

## 4.8 Security Screen

In this section, you may set or change the supervisor/user password for the system. For the user password, you may also clear it.

### **Secure Boot**

Enable to support Windows® 8.1 Secure Boot.

## 4.9 Exit Screen

### **Save Changes and Exit**

When you select this option, it will pop-out the following message, "Save configuration changes and exit setup?" Select [OK] to save the changes and exit the UEFI SETUP UTILITY.

### **Discard Changes and Exit**

When you select this option, it will pop-out the following message, "Discard changes and exit setup?" Select [OK] to exit the UEFI SETUP UTILITY without saving any changes.

### **Discard Changes**

When you select this option, it will pop-out the following message, "Discard changes?" Select [OK] to discard all changes.

### **Load UEFI Defaults**

Load UEFI default values for all the setup questions. F9 key can be used for this operation.

## Contact Information

If you need to contact ASRock or want to know more about ASRock, you're welcome to visit ASRock's website at <http://www.asrock.com>; or you may contact your dealer for further information. For technical questions, please submit a support request form at <http://www.asrock.com/support/tsd.asp>

### **ASRock Incorporation**

2F., No.37, Sec. 2, Jhongyang S. Rd., Beitou District,

Taipei City 112, Taiwan (R.O.C.)

### **ASRock EUROPE B.V.**

Bijsterhuizen 11-11

6546 AR Nijmegen

The Netherlands

Phone: +31-24-345-44-33

Fax: +31-24-345-44-38

### **ASRock America, Inc.**

13848 Magnolia Ave, Chino, CA91710

U.S.A.

Phone: +1-909-590-8308

Fax: +1-909-590-1026