



4Core1600-DVI

User Manual

Version 1.0

Published April 2008

Copyright©2008 ASRock INC. All rights reserved.

Copyright Notice:

No part of this manual may be reproduced, transcribed, transmitted, or translated in any language, in any form or by any means, except duplication of documentation by the purchaser for backup purpose, without written consent of ASRock Inc.

Products and corporate names appearing in this manual may or may not be registered trademarks or copyrights of their respective companies, and are used only for identification or explanation and to the owners' benefit, without intent to infringe.

Disclaimer:

Specifications and information contained in this manual are furnished for informational use only and subject to change without notice, and should not be constructed as a commitment by ASRock. ASRock assumes no responsibility for any errors or omissions that may appear in this manual.

With respect to the contents of this manual, ASRock does not provide warranty of any kind, either expressed or implied, including but not limited to the implied warranties or conditions of merchantability or fitness for a particular purpose.

In no event shall ASRock, its directors, officers, employees, or agents be liable for any indirect, special, incidental, or consequential damages (including damages for loss of profits, loss of business, loss of data, interruption of business and the like), even if ASRock has been advised of the possibility of such damages arising from any defect or error in the manual or product.



This device complies with Part 15 of the FCC Rules. Operation is subject to the following two conditions:

- (1) this device may not cause harmful interference, and
- (2) this device must accept any interference received, including interference that may cause undesired operation.

CALIFORNIA, USA ONLY

The Lithium battery adopted on this motherboard contains Perchlorate, a toxic substance controlled in Perchlorate Best Management Practices (BMP) regulations passed by the California Legislature. When you discard the Lithium battery in California, USA, please follow the related regulations in advance.

"Perchlorate Material-special handling may apply, see www.dtsc.ca.gov/hazardouswaste/perchlorate"

ASRock Website: <http://www.asrock.com>

Contents

1 Introduction	5
1.1 Package Contents	5
1.2 Specifications	6
1.3 Minimum Hardware Requirement Table for Windows® Vista™ Premium 2007 and Basic Logo.....	9
1.4 Motherboard Layout	10
1.5 ASRock 6CH I/O	11
2 Installation	12
2.1 Screw Holes	12
2.2 Pre-installation Precautions	12
2.3 CPU Installation	13
2.4 Installation of Heatsink and CPU fan	15
2.5 Installation of Memory Modules (DIMM)	16
2.6 Expansion Slots (PCI and PCI Express Slots)	18
2.7 DVI Graphics-SI Card Installation Guide	19
2.8 Jumpers Setup	21
2.9 Onboard Headers and Connectors	23
2.10 SATAII Hard Disk Setup Guide	27
2.11 Serial ATA (SATA) / Serial ATAII (SATAII) Hard Disks Installation	28
2.12 Driver Installation Guide	28
2.13 Untied Overclocking Technology	28
3 BIOS SETUP UTILITY	29
3.1 Introduction	29
3.1.1 BIOS Menu Bar	29
3.1.2 Navigation Keys	30
3.2 Main Screen	30
3.3 Advanced Screen	30
3.3.1 CPU Configuration	31
3.3.2 Chipset Configuration	33
3.3.3 ACPI Configuration	35
3.3.4 IDE Configuration	36
3.3.5 PCIPnP Configuration	38
3.3.6 Floppy Configuration	39
3.3.7 Super IO Configuration	39
3.3.8 USB Configuration	41
3.4 Hardware Health Event Monitoring Screen	41
3.5 Boot Screen	42
3.5.1 Boot Settings Configuration	43



3.6 Security Screen	43
3.7 Exit Screen	44
4 Software Support	45
4.1 Install Operating System	45
4.2 Support CD Information	45
4.2.1 Running Support CD	45
4.2.2 Drivers Menu	45
4.2.3 Utilities Menu	45
4.2.4 Contact Information	45



Chapter 1 Introduction

Thank you for purchasing ASRock **4Core1600-DVI** motherboard, a reliable motherboard produced under ASRock's consistently stringent quality control. It delivers excellent performance with robust design conforming to ASRock's commitment to quality and endurance.

In this manual, chapter 1 and 2 contain introduction of the motherboard and step-by-step guide to the hardware installation. Chapter 3 and 4 contain the configuration guide to BIOS setup and information of the Support CD.



Because the motherboard specifications and the BIOS software might be updated, the content of this manual will be subject to change without notice. In case any modifications of this manual occur, the updated version will be available on ASRock website without further notice. You may find the latest VGA cards and CPU support lists on ASRock website as well. ASRock website <http://www.asrock.com>
If you require technical support related to this motherboard, please visit our website for specific information about the model you are using.
www.asrock.com/support/index.asp

1.1 Package Contents

ASRock **4Core1600-DVI** Motherboard

(Micro ATX Form Factor: 9.6-in x 9.6-in, 24.4 cm x 24.4 cm)

ASRock **4Core1600-DVI** Quick Installation Guide

ASRock **4Core1600-DVI** Support CD

One 80-conductor Ultra ATA 66/100 IDE Ribbon Cable

One Ribbon Cable for a 3.5-in Floppy Drive

One Serial ATA (SATA) Data Cable (Optional)

One Serial ATA (SATA) HDD Power Cable (Optional)

One ASRock 6CH I/O Panel Shield

One DVI Graphics-SI Card

1.2 Specifications

Platform	- Micro ATX Form Factor: 9.6-in x 9.6-in, 24.4 cm x 24.4 cm
CPU	- LGA 775 for Intel® Core™ 2 Extreme / Core™ 2 Quad / Core™ 2 Duo / Pentium® Dual Core / Celeron®, supporting Penryn Quad Core Yorkfield and Dual Core Wolfdale processors - Compatible with all FSB1600/1333/1066/800MHz CPUs (see CAUTION 1) - Supports Hyper-Threading Technology (see CAUTION 2) - Supports Untied Overclocking Technology (see CAUTION 3) - Supports EM64T CPU
Chipset	- Northbridge: Intel® G31 - Southbridge: Intel® ICH7
Memory	- Dual Channel DDR2 Memory Technology (see CAUTION 4) - 4 x DDR2 DIMM slots (see CAUTION 5) - Support DDR2 800/667 non-ECC, un-buffered memory (see CAUTION 6) - Max. capacity of system memory: 4GB (see CAUTION 7)
Hybrid Booster	- CPU Frequency Stepless Control (see CAUTION 8) - ASRock U-COP (see CAUTION 9) - Boot Failure Guard (B.F.G.)
Expansion Slot	- 1 x PCI Express x16 slot - 1 x PCI Express x1 slot - 2 x PCI slots
Graphics	- Intel® Graphics Media Accelerator 3100 - Pixel Shader 2.0, DirectX 9.0 - Max. shared memory 384MB (see CAUTION 10) - Dual VGA Output: support D-Sub and DVI-D ports with DVI Graphics-SI card by independent display controllers
Audio	- 5.1 CH Windows® Vista™ Premium Level HD Audio (ALC662 Audio Codec)
LAN	- PCIe x1 Gigabit LAN 10/100/1000 Mb/s - Realtek RTL8111B/RTL8111C - Supports Wake-On-LAN
Rear Panel I/O	ASRock 6CH I/O - 1 x PS/2 Mouse Port - 1 x PS/2 Keyboard Port - 1 x Serial Port: COM1 - 1 x VGA Port - 1 x Parallel Port (ECP/EPP Support) - 4 x Ready-to-Use USB 2.0 Ports

	<ul style="list-style-type: none"> - 1 x RJ-45 LAN Port - HD Audio Jack: Line in / Front Speaker / Microphone
Connector	<ul style="list-style-type: none"> - 4 x Serial ATAII 3.0Gb/s connectors (No support for RAID and "Hot Plug" functions) (see CAUTION 11) - 1 x ATA100 IDE connector (supports 2 x IDE devices) - 1 x Floppy connector - 1 x DeskExpress Hot Plug Detection header - CPU/Chassis FAN connector - 24 pin ATX power connector - 4 pin 12V power connector - CD in header - Front panel audio connector - 2 x USB 2.0 headers (support 3 USB 2.0 ports) (see CAUTION 12) - 1 x WiFi/E header (see CAUTION 13)
BIOS Feature	<ul style="list-style-type: none"> - 4Mb AMI BIOS - AMI Legal BIOS - Supports "Plug and Play" - ACPI 1.1 Compliance Wake Up Events - Supports jumperfree - AMBIOS 2.3.1 Support
Support CD	<ul style="list-style-type: none"> - Drivers, Utilities, AntiVirus Software (Trial Version)
Hardware Monitor	<ul style="list-style-type: none"> - CPU Temperature Sensing - Chassis Temperature Sensing - CPU Fan Tachometer - Chassis Fan Tachometer - CPU Quiet Fan - Voltage Monitoring: +12V, +5V, +3.3V, CPU Vcore
OS	<ul style="list-style-type: none"> - Microsoft® Windows® 2000 / XP / XP 64-bit / Vista™ / Vista™ 64-bit compliant
Certifications	<ul style="list-style-type: none"> - FCC, CE, WHQL

* For detailed product information, please visit our website: <http://www.asrock.com>

WARNING

Please realize that there is a certain risk involved with overclocking, including adjusting the setting in the BIOS, applying Untied Overclocking Technology, or using the third-party overclocking tools. Overclocking may affect your system stability, or even cause damage to the components and devices of your system. It should be done at your own risk and expense. We are not responsible for possible damage caused by overclocking.

CAUTION!

1. FSB1600-CPU will operate in overclocking mode. Under this situation, PCIE frequency will also be overclocked to 120MHz. If you use a FSB1600-CPU on this motherboard, you need to adjust the jumpers. If you want to overclock the CPU you adopt from FSB800 to FSB1066, you need to adjust the jumpers as well. Please refer to page 21 for proper jumper settings.
2. About the setting of "Hyper Threading Technology", please check page 31.
3. This motherboard supports Untied Overclocking Technology. Please read "Untied Overclocking Technology" on page 27 for details.
4. This motherboard supports Dual Channel Memory Technology. Before you implement Dual Channel Memory Technology, make sure to read the installation guide of memory modules on page 16 for proper installation.
5. There are memory module installation limitations on this motherboard, please read "Installation of Memory Modules (DIMM)" on page 16 for details.
6. Please check the table below for the CPU FSB frequency and its corresponding memory support frequency.

CPU FSB Frequency	Memory Support Frequency
1600	DDR2 800
1333	DDR2 667, DDR2 800
1066	DDR2 667, DDR2 800
800	DDR2 667, DDR2 800

7. Due to the operating system limitation, the actual memory size may be less than 4GB for the reservation for system usage under Windows® XP and Windows® Vista™. For Windows® XP 64-bit and Windows® Vista™ 64-bit with 64-bit CPU, there is no such limitation.
8. Although this motherboard offers stepless control, it is not recommended to perform over-clocking. Frequencies other than the recommended CPU bus frequencies may cause the instability of the system or damage the CPU.
9. While CPU overheat is detected, the system will automatically shutdown. Before you resume the system, please check if the CPU fan on the motherboard functions properly and unplug the power cord, then plug it back again. To improve heat dissipation, remember to spray thermal grease between the CPU and the heatsink when you install the PC system.
10. The maximum shared memory size is defined by the chipset vendor and is subject to change. Please check Intel® website for the latest information.
11. Before installing SATAII hard disk to SATAII connector, please read the "SATAII Hard Disk Setup Guide" on page 26 to adjust your SATAII hard disk drive to SATAII mode. You can also connect SATA hard disk to SATAII connector directly.

-
12. Power Management for USB 2.0 works fine under Microsoft® Windows® Vista™ 64-bit / Vista™ / XP 64-bit / XP SP1 or SP2 / 2000 SP4.
 13. WiFi/E header supports WiFi+AP function with ASRock WiFi-802.11g or WiFi-802.11n module, an easy-to-use wireless local area network (WLAN) adapter. It allows you to create a wireless environment and enjoy the convenience of wireless network connectivity. Please visit our website for the availability of ASRock WiFi-802.11g or WiFi-802.11n module. ASRock website <http://www.asrock.com>

1.3 Minimum Hardware Requirement Table for Windows® Vista™ Premium 2007 and Basic Logo

For system integrators and users who purchase this motherboard and plan to submit Windows® Vista™ Premium 2007 and Basic logo, please follow below table for minimum hardware requirements.

CPU	Celeron 420
Memory	512MB x 2 Dual Channel (Premium)
	512MB Single Channel (Basic)
	256MB x 2 Dual Channel (Basic)
VGA	DX9.0 with WDDM Driver

- * If you plan to use onboard VGA to submit Windows® Vista™ logo, please keep the default setting of "DVMT Mode Select" option under BIOS.
- * If you plan to use external graphics card on this motherboard, please refer to Premium Discrete requirement at <http://www.asrock.com>
- * After June 1, 2007, all Windows® Vista™ systems are required to meet above minimum hardware requirements in order to qualify for Windows® Vista™ Premium 2007 logo.

1.4 Motherboard Layout

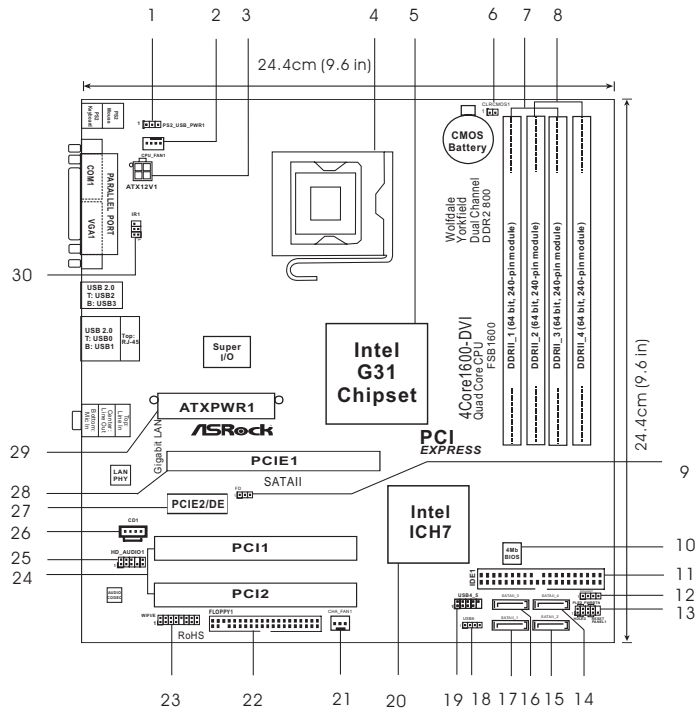

- | | |
|---|--|
| 1 PS2_USB_PWR1 Jumper | 16 Third SATAII Connector (SATAII_3) |
| 2 CPU Fan Connector (CPU_FAN1) | 17 Primary SATAII Connector (SATAII_1) |
| 3 ATX 12V Connector (ATX12V1) | 18 USB 2.0 Header (USB6, Blue) |
| 4 775-Pin CPU Socket | 19 USB 2.0 Header (USB4_5, Blue) |
| 5 North Bridge Controller | 20 South Bridge Controller |
| 6 Clear CMOS Jumper (CLRCMOS1) | 21 Chassis Fan Connector (CHA_FAN1) |
| 7 2 x 240-pin DDR2 DIMM Slots
(Dual Channel A: DDRII_1, DDRII_3; Yellow) | 22 Floppy Connector (FLOPPY1) |
| 8 2 x 240-pin DDR2 DIMM Slots
(Dual Channel B: DDRII_2, DDRII_4; Orange) | 23 WiFi/E Header (WIFI/E) |
| 9 FD Jumper | 24 PCI Slots (PCI1 - 2) |
| 10 Flash Memory | 25 Front Panel Audio Header (HD_AUDIO1) |
| 11 IDE1 Connector (IDE1, Blue) | 26 Internal Audio Connector: CD1 (Black) |
| 12 Chassis Speaker Header (SPEAKER 1) | 27 PCI Express x1 Slot (PCIE2/DE) |
| 13 System Panel Header (PANEL1) | 28 PCI Express x16 Slot (PCIE1) |
| 14 Fourth SATAII Connector (SATAII_4) | 29 ATX Power Connector (ATXPWR1) |
| 15 Secondary SATAII Connector (SATAII_2) | 30 DeskExpress Hot Plug Detection Header (IR1) |

1.5 ASRock 6CH I/O

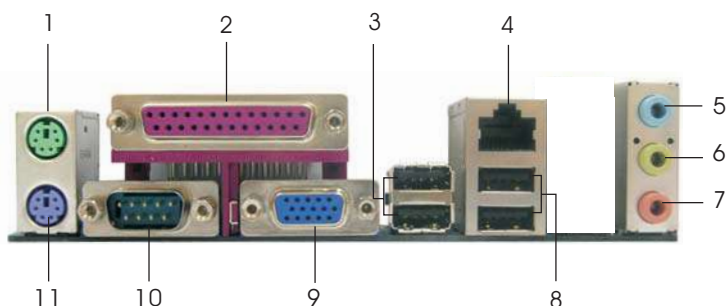

- | | | | |
|---|-------------------------|----|-----------------------------|
| 1 | PS/2 Mouse Port (Green) | 7 | Microphone (Pink) |
| 2 | Parallel Port | 8 | USB 2.0 Ports (USB01) |
| 3 | USB 2.0 Ports (USB23) | 9 | VGA Port |
| 4 | RJ-45 Port | 10 | COM Port |
| 5 | Line In (Light Blue) | 11 | PS/2 Keyboard Port (Purple) |
| 6 | Line Out (Lime) | | |

* To enable Multi-Streaming function, you need to connect a front panel audio cable to the front panel audio header. Please refer to below steps for the software setting of Multi-Streaming.

For Windows® XP:

After restarting your computer, you will find "Mixer" tool on your system. Please select "Mixer ToolBox" , click "Enable playback multi-streaming", and click "ok". Choose "2CH" or

"4CH" and then you are allowed to select "Realtek HDA Primary output" to use Rear Speaker and Front Speaker, or select "Realtek HDA Audio 2nd output" to use front panel audio. Then reboot your system.

For Windows® Vista™:

After restarting your computer, please double-click "Realtek HD Audio Manager" on the system tray. Set "Speaker Configuration" to "Quadraphonic" or "Stereo". Click "Device advanced settings", choose "Make front and rear output devices playbacks two different audio streams simultaneously", and click "ok". Then reboot your system.

Chapter 2 Installation

4Core1600-DVI is a Micro ATX form factor (9.6" x 9.6", 24.4 x 24.4 cm) motherboard. Before you install the motherboard, study the configuration of your chassis to ensure that the motherboard fits into it.



Make sure to unplug the power cord before installing or removing the motherboard. Failure to do so may cause physical injuries to you and damages to motherboard components.

2.1 Screw Holes

Place screws into the holes indicated by circles to secure the motherboard to the chassis.



Do not over-tighten the screws! Doing so may damage the motherboard.

2.2 Pre-installation Precautions

Take note of the following precautions before you install motherboard components or change any motherboard settings.

1. Unplug the power cord from the wall socket before touching any component.
2. To avoid damaging the motherboard components due to static electricity, **NEVER** place your motherboard directly on the carpet or the like. Also remember to use a grounded wrist strap or touch a safety grounded object before you handle components.
3. Hold components by the edges and do not touch the ICs.
4. Whenever you uninstall any component, place it on a grounded antistatic pad or in the bag that comes with the component.



Before you install or remove any component, ensure that the power is switched off or the power cord is detached from the power supply. Failure to do so may cause severe damage to the motherboard, peripherals, and/or components.

2.3 CPU Installation

For the installation of Intel 775-LAND CPU, please follow the steps below.

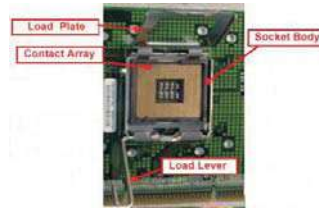

775-Pin Socket Overview



Before you insert the 775-LAND CPU into the socket, please check if the CPU surface is unclean or if there is any bent pin on the socket. Do not force to insert the CPU into the socket if above situation is found. Otherwise, the CPU will be seriously damaged.

Step 1. Open the socket:

Step 1-1. Disengaging the lever by depressing down and out on the hook to clear retention tab.



Step 1-2. Rotate the load lever to fully open position at approximately 135 degrees.

Step 1-3. Rotate the load plate to fully open position at approximately 100 degrees.

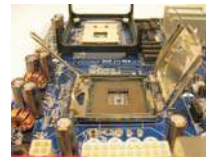

Step 2. Insert the 775-LAND CPU:

Step 2-1. Hold the CPU by the edges where are marked with black lines.

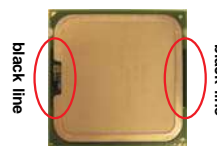

Step 2-2. Orient the CPU with IHS (Integrated Heat Sink) up. Locate Pin1 and the two orientation key notches.

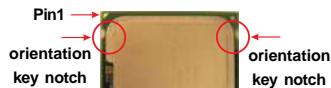

775-LAND CPU



775-Pin Socket



For proper inserting, please ensure to match the two orientation key notches of the CPU with the two alignment keys of the socket.

Step 2-3. Carefully place the CPU into the socket by using a purely vertical motion.

Step 2-4. Verify that the CPU is within the socket and properly mated to the orient keys.



Step 3. Remove PnP Cap (Pick and Place Cap):

Use your left hand index finger and thumb to support the load plate edge, engage PnP cap with right hand thumb and peel the cap from the socket while pressing on center of PnP cap to assist in removal.



1. It is recommended to use the cap tab to handle and avoid kicking off the PnP cap.
2. This cap must be placed if returning the motherboard for after service.

Step 4. Close the socket:

Step 4-1. Rotate the load plate onto the IHS.

Step 4-2. While pressing down lightly on load plate, engage the load lever.

Step 4-3. Secure load lever with load plate tab under retention tab of load lever.



2.4 Installation of CPU Fan and Heatsink

This motherboard is equipped with 775-Pin socket that supports Intel 775-LAND CPU. Please adopt the type of heatsink and cooling fan compliant with Intel 775-LAND CPU to dissipate heat. Before you installed the heatsink, you need to spray thermal interface material between the CPU and the heatsink to improve heat dissipation. Ensure that the CPU and the heatsink are securely fastened and in good contact with each other. Then connect the CPU fan to the CPU_FAN connector (CPU_FAN1, see page 10, No. 2).

For proper installation, please kindly refer to the instruction manuals of your CPU fan and heatsink.

Below is an example to illustrate the installation of the heatsink for 775-LAND CPU.

Step 1. Apply thermal interface material onto center of IHS on the socket surface.



Step 2. Place the heatsink onto the socket. Ensure fan cables are oriented on side closest to the CPU fan connector on the motherboard (CPU_FAN1, see page 10, No. 2).



Step 3. Align fasteners with the motherboard throughholes.

Step 4. Rotate the fastener clockwise, then press down on fastener caps with thumb to install and lock. Repeat with remaining fasteners.



If you press down the fasteners without rotating them clockwise, the heatsink cannot be secured on the motherboard.

Step 5. Connect fan header with the CPU fan connector on the motherboard.

Step 6. Secure excess cable with tie-wrap to ensure cable does not interfere with fan operation or contact other components.

2.5 Installation of Memory Modules (DIMM)

4Core1600-DVI motherboard provides four 240-pin DDR2 (Double Data Rate 2) DIMM slots, and supports Dual Channel Memory Technology. For dual channel configuration, you always need to install **identical** (the same brand, speed, size and chip-type) DDR2 DIMM pair in the slots of the same color. In other words, you have to install **identical** DDR2 DIMM pair in **Dual Channel A** (DDRII_1 and DDRII_3; Yellow slots; see p.10 No.7) or **identical** DDR2 DIMM pair in **Dual Channel B** (DDRII_2 and DDRII_4; Orange slots; see p.10 No.8), so that Dual Channel Memory Technology can be activated. This motherboard also allows you to install four DDR2 DIMMs for dual channel configuration, and please install **identical** DDR2 DIMMs in all four slots. You may refer to the Dual Channel Memory Configuration Table below.

Dual Channel Memory Configurations (DS: Double Side, SS: Single Side)

	DDRII_1 (Yellow Slot)	DDRII_2 (Orange Slot)	DDRII_3 (Yellow Slot)	DDRII_4 (Orange Slot)
2 memory modules	SS	X	SS	X
2 memory modules	DS	X	DS	X
2 memory modules	X	SS	X	SS
2 memory modules	X	DS	X	DS
4 memory modules	SS	SS	SS	SS



1. If you want to install two memory modules, for optimal compatibility and reliability, it is recommended to install them in the slots of the same color. In other words, install them either in the set of yellow slots (DDRII_1 and DDRII_3), or in the set of orange slots (DDRII_2 and DDRII_4).
2. If only one memory module or three memory modules are installed in the DDR2 DIMM slots on this motherboard, it is unable to activate the Dual Channel Memory Technology.
3. If a pair of memory modules is NOT installed in the same Dual Channel, for example, installing a pair of memory modules in DDRII_1 and DDRII_2, it is unable to activate the Dual Channel Memory Technology .
4. It is not allowed to install a DDR memory module into DDR2 slot; otherwise, this motherboard and DIMM may be damaged.

Recommended Memory Configurations
(DS: Double Side, SS: Single Side)

	DDRII_1 (Yellow Slot)	DDRII_2 (Orange Slot)	DDRII_3 (Yellow Slot)	DDRII_4 (Orange Slot)
1 memory module	DS/SS*	X	X	X
2 memory modules	DS/SS	X	DS/SS	X
2 memory modules	X	DS/SS	X	DS/SS
3 memory modules	SS	SS	DS/SS	X
4 memory modules	SS	SS	SS	SS

* If you only install one memory module, you can install it to any one of the four slots.

Installing a DIMM



Please make sure to disconnect power supply before adding or removing DIMMs or the system components.

- Step 1. Unlock a DIMM slot by pressing the retaining clips outward.
- Step 2. Align a DIMM on the slot such that the notch on the DIMM matches the break on the slot.

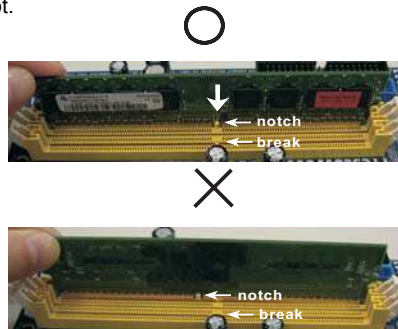

The DIMM only fits in one correct orientation. It will cause permanent damage to the motherboard and the DIMM if you force the DIMM into the slot at incorrect orientation.

- Step 3. Firmly insert the DIMM into the slot until the retaining clips at both ends fully snap back in place and the DIMM is properly seated.

2.6 Expansion Slots (PCI and PCI Express Slots)

There are 2 PCI slots and 2 PCI Express slots on this motherboard.

PCI slots: PCI slots are used to install expansion cards that have the 32-bit PCI interface.

PCI Express slots: PCIE1 (PCI Express x16 slot) is used for PCI Express cards with x16 lane width graphics cards or DVI Graphics-SI card.

PCIE2/DE (PCI Express x1 slot) is used for PCI Express cards with x1 lane width cards, such as Gigabit LAN card, SATA2 card and ASRock PCIE_DE card.



1. If you install the add-on PCI Express VGA card to PCIE1 (PCI Express x16 slot), the onboard VGA will be disabled. If you install the add-on PCI Express VGA card to PCIE1 (PCI Express x16 slot) and adjust the "Internal Graphics Mode Select" BIOS option to [Enabled], the onboard VGA will be enabled, and the primary screen will be onboard VGA.
2. If you want to use ASRock DeskExpress function on this motherboard, please install ASRock PCIE_DE card on PCIE2/DE slot.
3. You can only choose either PCI Express VGA card or DVI Graphics-SI card to install on PCIE1 (PCI Express x16 slot).

Installing an expansion card

- Step 1. Before installing the expansion card, please make sure that the power supply is switched off or the power cord is unplugged. Please read the documentation of the expansion card and make necessary hardware settings for the card before you start the installation.
- Step 2. Remove the bracket facing the slot that you intend to use. Keep the screws for later use.
- Step 3. Align the card connector with the slot and press firmly until the card is completely seated on the slot.
- Step 4. Fasten the card to the chassis with screws.

2.7 DVI Graphics-SI Card Installation Guide

With the onboard VGA/D-Sub output and the external installation of our DVI Graphics-SI card, this motherboard provides users with dual VGA output support: DVI-D and D-Sub. You can easily enjoy the benefits of dual VGA output support by connecting the D-Sub monitor to the VGA/D-Sub port on the I/O panel and connecting the DVI-D monitor to our DVI Graphics-SI card inserted to PCIE1 (PCIE x16 slot) on this motherboard. Please refer to below procedures for proper installation of DVI Graphics-SI card.

- Step 1. Install the DVI Graphics-SI card to PCIE1 (PCIE x16 slot). Please refer to the expansion card installation procedures on page 18 for details.



DVI Graphics-SI card

- Step 2. Connect the DVI-D monitor to the DVI-D output connector of DVI Graphics-SI card which is inserted to PCIE1 (PCIE x16 slot) on this motherboard.

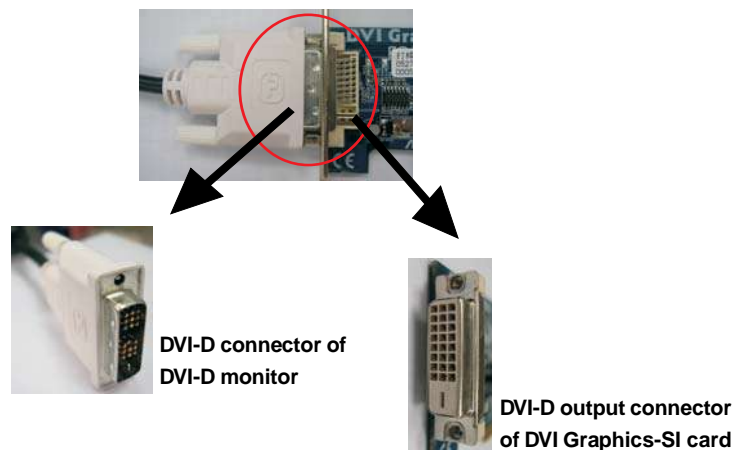



-
- Step 3. Connect the D-Sub monitor to the VGA/D-Sub port on the I/O panel of this motherboard.
- Step 4. If you have installed Intel® VGA driver from our support CD to your system already, you can freely enjoy the benefits of DVI-D output function with this motherboard after your system boots. If you haven't installed Intel® VGA driver yet, please install Intel® VGA driver from our support CD to your system and restart your computer. Then you can start to use DVI-D output function with this motherboard.

2.8 Jumpers Setup

The illustration shows how jumpers are setup.

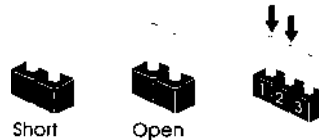
When the jumper cap is placed on pins, the jumper is "Short". If no jumper cap is placed on pins, the jumper is "Open". The illustration shows a 3-pin jumper whose pin1 and pin2 are "Short" when jumper cap is placed on these 2 pins.



Jumper	Setting	Description
PS2_USB_PWR1 (see p.10 No. 1)	<div style="display: flex; justify-content: space-around;"> <div style="text-align: center;"> <p>1_2</p>  <p>+5V</p> </div> <div style="text-align: center;"> <p>2_3</p>  <p>+5VSB</p> </div> </div>	Short pin2, pin3 to enable +5VSB (standby) for PS/2 or USB wake up events.

Note: To select +5VSB, it requires 2 Amp and higher standby current provided by power supply.

Clear CMOS
(CLR CMOS1, 2-pin jumper)
(see p.10 No. 6)



Note: CLR CMOS1 allows you to clear the data in CMOS. The data in CMOS includes system setup information such as system password, date, time, and system setup parameters. To clear and reset the system parameters to default setup, please turn off the computer and unplug the power cord from the power supply. After waiting for 15 seconds, use a jumper cap to short 2 pins on CLR CMOS1 for 5 seconds.

FD Jumper
(FD, 3-pin jumper, see p.10 No. 9)

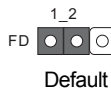

Note1: If you use a FSB1600-CPU on this motherboard, you need to adjust the jumpers. Please short pin2, pin3 for FD jumper. Otherwise, the CPU may not work properly on this motherboard. Please refer to below jumper settings.



Note2: If you want to overclock the FSB800-CPU you adopt to FSB1066 on this motherboard, you need to adjust the jumpers. Please short pin2, pin3 for FD jumper. Otherwise, the CPU may not work properly on this motherboard. Please refer to below jumper settings.



2.9 Onboard Headers and Connectors



Onboard headers and connectors are NOT jumpers. Do NOT place jumper caps over these headers and connectors. Placing jumper caps over the headers and connectors will cause permanent damage of the motherboard!

FDD connector
(33-pin FLOPPY1)
(see p.10 No. 22)



Note: Make sure the red-striped side of the cable is plugged into Pin1 side of the connector.

Primary IDE connector (Blue)

(39-pin IDE1, see p.10 No. 11)

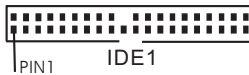

connect the blue end
to the motherboard



connect the black end
to the IDE devices

80-conductor ATA 66/100 cable

Note: Please refer to the instruction of your IDE device vendor for the details.

Serial ATAII Connectors

(SATAII_1: see p.10, No. 17)

(SATAII_2: see p.10, No. 15)

(SATAII_3: see p.10, No. 16)

(SATAII_4: see p.10, No. 14)



These four Serial ATAII (SATAII) connectors support SATA data cables for internal storage devices. The current SATAII interface allows up to 3.0 Gb/s data transfer rate.

Serial ATA (SATA)

Data Cable

(Optional)



Either end of the SATA data cable can be connected to the SATA / SATAII hard disk or the SATAII connector on this motherboard.

Serial ATA (SATA)

Power Cable

(Optional)

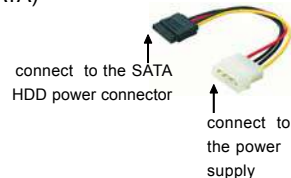

Please connect the black end of SATA power cable to the power connector on each drive. Then connect the white end of SATA power cable to the power connector of the power supply.

USB 2.0 Headers

(9-pin USB4_5)
(see p.10 No. 19)

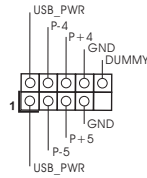

Besides four default USB 2.0 ports on the I/O panel, there are two USB 2.0 headers on this motherboard. USB4_5 header can support two USB 2.0 ports, and USB6 header can support one USB 2.0 port.

(4-pin USB6)
(see p.10 No. 18)

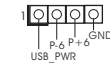

WiFi/E Header

(15-pin WiFi/E)
(see p.10 No. 23)

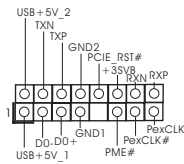

This header supports WiFi+AP function with ASRock WiFi-802.11g or WiFi-802.11n module, an easy-to-use wireless local area network (WLAN) adapter. It allows you to create a wireless environment and enjoy the convenience of wireless network connectivity.



If you don't plan to use WiFi+AP function on this motherboard, this header can be used as a 4-Pin USB 2.0 header to support one USB 2.0 port. To connect the 4-Pin USB device cable to this header, please refer to this picture for proper installation.

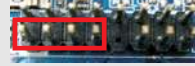

DeskExpress Hot Plug Detection Header

(5-pin IR1)
(see p.10 No. 30)

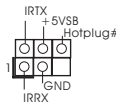

This header supports the Hot Plug detection function for ASRock DeskExpress.

Internal Audio Connectors

(4-pin CD1)
(CD1: see p.10 No. 26)

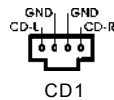

This connector allows you to receive stereo audio input from sound sources such as a CD-ROM, DVD-ROM, TV tuner card, or MPEG card.

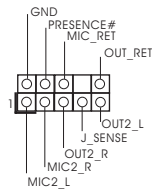

Front Panel Audio Header

(9-pin HD_AUDIO1)
(see p.10 No. 25)



This is an interface for front panel audio cable that allows convenient connection and control of audio devices.



1. High Definition Audio supports Jack Sensing, but the panel wire on the chassis must support HDA to function correctly. Please follow the instruction in our manual and chassis manual to install your system.
2. If you use AC'97 audio panel, please install it to the front panel audio header as below:
 - A. Connect Mic_IN (MIC) to MIC2_L.
 - B. Connect Audio_R (RIN) to OUT2_R and Audio_L (LIN) to OUT2_L.
 - C. Connect Ground (GND) to Ground (GND).
 - D. MIC_RET and OUT_RET are for HD audio panel only. You don't need to connect them for AC'97 audio panel.
 - E. Enter BIOS Setup Utility. Enter Advanced Settings, and then select Chipset Configuration. Set the Front Panel Control option from [Auto] to [Enabled].
 - F. Enter Windows system. Click the icon on the lower right hand taskbar to enter Realtek HD Audio Manager.
For Windows® 2000 / XP / XP 64-bit OS:
Click "Audio I/O", select "Connector Settings" , choose "Disable front panel jack detection", and save the change by clicking "OK".
For Windows® Vista™ / Vista™ 64-bit OS:
Click the right-top "Folder" icon , choose "Disable front panel jack detection", and save the change by clicking "OK".

System Panel Header

(9-pin PANEL1)
(see p.10 No. 13)

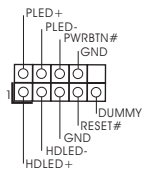

This header accommodates several system front panel functions.

Chassis Speaker Header

(4-pin SPEAKER 1)
(see p.10 No. 12)

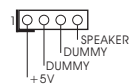

Please connect the chassis speaker to this header.

Chassis Fan Connector

(3-pin CHA_FAN1)
(see p.10 No. 21)

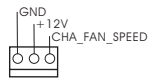

Please connect a chassis fan cable to this connector and match the black wire to the ground pin.

CPU Fan Connector

(4-pin CPU_FAN1)
(see p.10 No. 2)

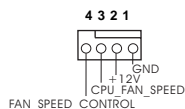

Please connect a CPU fan cable to this connector and match the black wire to the ground pin.



Though this motherboard provides 4-Pin CPU fan (Quiet Fan) support, the 3-Pin CPU fan still can work successfully even without the fan speed control function. If you plan to connect the 3-Pin CPU fan to the CPU fan connector on this motherboard, please connect it to Pin 1-3.

Pin 1-3 Connected

3-Pin Fan Installation



ATX Power Connector

(24-pin ATXPWR1)
(see p.10, No. 29)

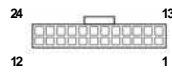

Please connect an ATX power supply to this connector.



Though this motherboard provides 24-pin ATX power connector, it can still work if you adopt a traditional 20-pin ATX power supply. To use the 20-pin ATX power supply, please plug your power supply along with Pin 1 and Pin 13.

20-Pin ATX Power Supply Installation



ATX 12V Connector

(4-pin ATX12V1)
(see p.10 No. 3)



Please connect an ATX 12V power supply to this connector.

2.10 SATAII Hard Disk Setup Guide

Before installing SATAII hard disk to your computer, please carefully read below SATAII hard disk setup guide. Some default setting of SATAII hard disks may not be at SATAII mode, which operate with the best performance. In order to enable SATAII function, please follow the below instruction with different vendors to correctly adjust your SATAII hard disk to SATAII mode in advance; otherwise, your SATAII hard disk may fail to run at SATAII mode.

Western Digital

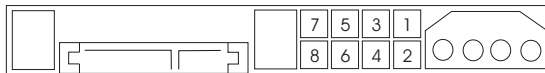

If pin 5 and pin 6 are shorted, SATA 1.5Gb/s will be enabled.

On the other hand, if you want to enable SATAII 3.0Gb/s, please remove the jumpers from pin 5 and pin 6.

SAMSUNG

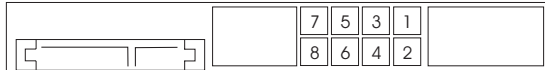

If pin 3 and pin 4 are shorted, SATA 1.5Gb/s will be enabled.

On the other hand, if you want to enable SATAII 3.0Gb/s, please remove the jumpers from pin 3 and pin 4.

HITACHI

Please use the Feature Tool, a DOS-bootable tool, for changing various ATA features. Please visit HITACHI's website for details:

<http://www.hitachigst.com/hdd/support/download.htm>



The above examples are just for your reference. For different SATAII hard disk products of different vendors, the jumper pin setting methods may not be the same. Please visit the vendors' website for the updates.

2.11 Serial ATA (SATA) / Serial ATAII (SATAII) Hard Disks Installation

This motherboard adopts Intel® ICH7 south bridge chipset that supports Serial ATA (SATA) / Serial ATAII (SATAII) hard disks. You may install SATA / SATAII hard disks on this motherboard for internal storage devices. This section will guide you to install the SATA / SATAII hard disks.

STEP 1: Install the SATA / SATAII hard disks into the drive bays of your chassis.

STEP 2: Connect the SATA power cable to the SATA / SATAII hard disk.

STEP 3: Connect one end of the SATA data cable to the motherboard's SATAII connector.

STEP 4: Connect the other end of the SATA data cable to the SATA / SATAII hard disk.

2.12 Driver Installation Guide

To install the drivers to your system, please insert the support CD to your optical drive first. Then, the drivers compatible to your system can be auto-detected and listed on the support CD driver page. Please follow the order from up to bottom side to install those required drivers. Therefore, the drivers you install can work properly.

2.13 Untied Overclocking Technology

This motherboard supports Untied Overclocking Technology, which means during overclocking, FSB enjoys better margin due to fixed PCI / PCIE buses. Before you enable Untied Overclocking function, please enter "Overclock Mode" option of BIOS setup to set the selection from [Auto] to [Manual]. Therefore, CPU FSB is untied during overclocking, but PCI / PCIE buses are in the fixed mode so that FSB can operate under a more stable overclocking environment.



Please refer to the warning on page 7 for the possible overclocking risk before you apply Untied Overclocking Technology.

Chapter 3 BIOS SETUP UTILITY

3.1 Introduction

This section explains how to use the BIOS SETUP UTILITY to configure your system. The BIOS FWH chip on the motherboard stores the BIOS SETUP UTILITY. You may run the BIOS SETUP UTILITY when you start up the computer. Please press <F2> during the Power-On-Self-Test (POST) to enter the BIOS SETUP UTILITY, otherwise, POST will continue with its test routines.

If you wish to enter the BIOS SETUP UTILITY after POST, restart the system by pressing <Ctl> + <Alt> + <Delete>, or by pressing the reset button on the system chassis. You may also restart by turning the system off and then back on.



Because the BIOS software is constantly being updated, the following BIOS setup screens and descriptions are for reference purpose only, and they may not exactly match what you see on your screen.

3.1.1 BIOS Menu Bar

The top of the screen has a menu bar with the following selections:

- Main** To set up the system time/date information
- Advanced** To set up the advanced BIOS features
- H/W Monitor** To display current hardware status
- Boot** To set up the default system device to locate and load the Operating System
- Security** To set up the security features
- Exit** To exit the current screen or the BIOS SETUP UTILITY

Use <←> key or <→> key to choose among the selections on the menu bar, and then press <Enter> to get into the sub screen.

3.1.2 Navigation Keys

Please check the following table for the function description of each navigation key.

Navigation Key(s)	Function Description
← / →	Moves cursor left or right to select Screens
↑ / ↓	Moves cursor up or down to select items
+ / -	To change option for the selected items
<Enter>	To bring up the selected screen
<F1>	To display the General Help Screen
<F9>	To load optimal default values for all the settings
<F10>	To save changes and exit the BIOS SETUP UTILITY
<ESC>	To jump to the Exit Screen or exit the current screen

3.2 Main Screen

When you enter the BIOS SETUP UTILITY, the Main screen will appear and display the system overview

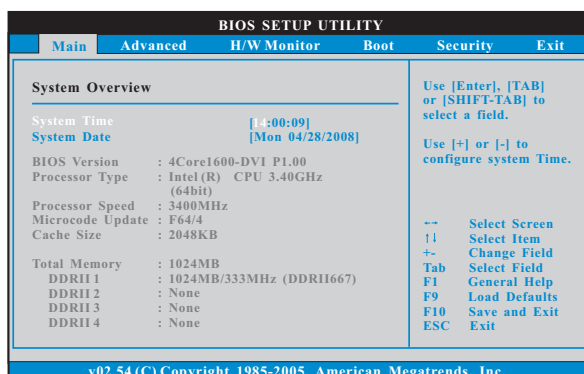

System Time [Hour:Minute:Second]

Use this item to specify the system time.

System Date [Day Month/Date/Year]

Use this item to specify the system date.

3.3 Advanced Screen

In this section, you may set the configurations for the following items: CPU Configuration, Chipset Configuration, ACPI Configuration, IDE Configuration, PCIPnP Configuration, Floppy Configuration, SuperIO Configuration, and USB Configuration.

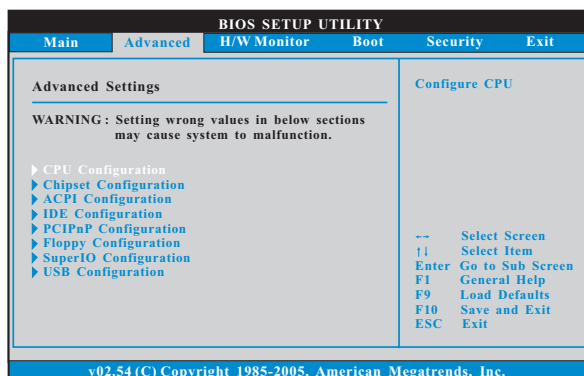

Setting wrong values in this section may cause the system to malfunction.

3.3.1 CPU Configuration

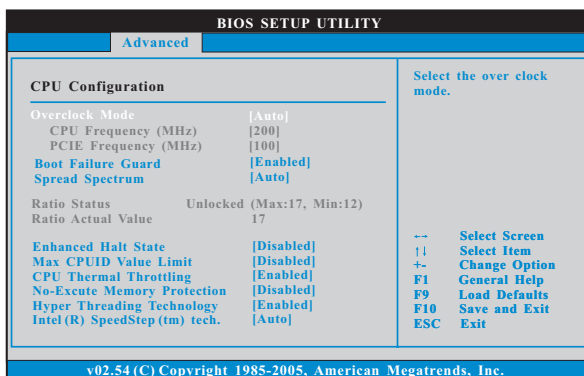

Overclock Mode

Use this to select Overclock Mode. The default value is [Auto]. Configuration options: [Auto] and [Manual].

CPU Frequency (MHz)

Use this option to adjust CPU frequency.

PCIE Frequency (MHz)

Use this option to adjust PCIE frequency.

Boot Failure Guard

Enable or disable the feature of Boot Failure Guard.

Spread Spectrum

This item should always be [Auto] for better system stability.

Ratio Status

This is a read-only item, which displays whether the ratio status of this motherboard is “Locked” or “Unlocked”. If it shows “Unlocked”, you will find an item **Ratio CMOS Setting** appears to allow you changing the ratio value of this motherboard.

Ratio Actual Value

This is a read-only item, which displays the ratio actual value of this motherboard.

Enhance Halt State

All processors support the Halt State (C1). The C1 state is supported through the native processor instructions HLT and MWAIT and requires no hardware support from the chipset. In the C1 power state, the processor maintains the context of the system caches.

Max CPUID Value Limit

For Prescott CPU only, some OSes (ex. NT4.0) cannot handle the function with disable. This should be enabled in order to boot legacy OSes that cannot support CPUs with extended CPUID functions.

Intel (R) Virtualization tech.

When this option is set to [Enabled], a VMM (Virtual Machine Architecture) can utilize the additional hardware capabilities provided by Vanderpool Technology. This option will be hidden if the installed CPU does not support Intel (R) Virtualization Technology.

CPU Thermal Throttling

You may select [Enabled] to enable P4 CPU internal thermal control mechanism to keep the CPU from overheated.

No-Execute Memory Protection

No-Execution (NX) Memory Protection Technology is an enhancement to the IA-32 Intel Architecture. An IA-32 processor with “No Execute (NX) Memory Protection” can prevent data pages from being used by malicious software to execute code. This option will be hidden if the current CPU does not support No-Execute Memory Protection.

Hyper Threading Technology

To enable this feature, it requires a computer system with an Intel Pentium® 4 processor that supports Hyper-Threading technology and an operating system that includes optimization for this technology, such as Microsoft® Windows® XP. Set to [Enabled] if using Microsoft® Windows® XP, or Linux kernel version 2.4.18 or higher. This option will be hidden if the installed CPU does not support Hyper-Threading technology.

Intel (R) SpeedStep(tm) tech.

Intel (R) SpeedStep(tm) tech. is Intel's new power saving technology. Processor can switch between multiple frequency and voltage points to enable power

savings. The default value is [Auto]. Configuration options: [Auto], [Enabled] and [Disabled]. If you install Windows® XP and select [Auto], you need to set the “Power Schemes” as “Portable/Laptop” to enable this function. If you install Windows® Vista™ and want to enable this function, please set this item to [Enabled]. This item will be hidden if the current CPU does not support Intel (R) SpeedStep(tm) tech..



Please note that enabling this function may reduce CPU voltage and lead to system stability or compatibility issue with some power supplies. Please set this item to [Disable] if above issue occurs.

3.3.2 Chipset Configuration

BIOS SETUP UTILITY		
Advanced		
Chipset Configuration		
Memory Remap Feature	[Disabled]	ENABLE: Allow remapping of overlapped PCI memory above the total physical memory. DISABLE: Do not allow remapping of memory.
DRAM Frequency	[Auto]	
Flexibility Option	[Disabled]	
DRAM CAS# Latency	[Auto]	
DRAM RAS# to CAS# Delay	[Auto]	
DRAM RAS# Precharge	[Auto]	
DRAM RAS# Activate to Precha	[Auto]	
Primary Graphics Adapter	[PCI]	
Internal Graphics Mode Select	[Auto]	
DVMT Mode Select	[DVMT Mode]	-- Select Screen
DVMT/FIXED Memory	[256MB]	+ Select Item
		+ - Change Option
OnBoard HD Audio	[Auto]	F1 General Help
Front Panel	[Auto]	F9 Load Defaults
OnBoard Lan	[Enabled]	F10 Save and Exit
		ESC Exit
DRAM Voltage	[Auto]	
v02.54 (C) Copyright 1985-2005, American Megatrends, Inc.		

Memory Remap Feature

Use this item to enable or disable memory remap feature. Configuration options: [Enabled] and [Disabled]. The default value is [Disabled].

DRAM Frequency

If [Auto] is selected, the motherboard will detect the memory module(s) inserted and assigns appropriate frequency automatically. You may also select other value as operating frequency: [333MHz (DDR1667)], [400MHz (DDR1800)].

Flexibility Option

The default value of this option is [Disabled]. It will allow better tolerance for memory compatibility when it is set to [Enabled].

DRAM CAS# Latency

Use this item to adjust the means of memory accessing. Configuration options are [6], [5], [4], [3] and [Auto].

DRAM RAS# to CAS# Delay

This controls the latency between the DRAM active command and the read / write command. Configuration options: [Auto], [3 DRAM Clocks], [4 DRAM Clocks], [5 DRAM Clocks] and [6 DRAM Clocks].

DRAM RAS# Precharge

This controls the idle clocks after a precharge command is issued. Configuration options: [Auto], [3 DRAM Clocks], [4 DRAM Clocks], [5 DRAM Clocks] and [6 DRAM Clocks].

DRAM RAS# Activate to Precharge

This controls the number of DRAM clocks for TRAS. Configuration options: Configuration options: [Auto], [9 DRAM Clocks], [10 DRAM Clocks], [11 DRAM Clocks], [12 DRAM Clocks], [13 DRAM Clocks], [14 DRAM Clocks] and [15 DRAM Clocks].

Primary Graphics Adapter

This allows you to select [Onboard], [PCI] or [PCI Express] as the boot graphic adapter priority. The default value is [PCI].

Internal Graphics Mode Select

If you select [Auto], the onboard VGA will be automatically disabled when you install VGA card; the onboard VGA will be enabled without the installation of any add-on VGA card. If you select [Enabled, 8MB] or [Enabled, 1MB], the onboard VGA will be enabled.

DVMT Mode Select

Use this option to adjust DVMT mode. Configuration options: [Fixed Mode] and [DVMT Mode]. The default value is [DVMT Mode]. DVMT (Dynamic Video Memory Technology) is an architecture that offers breakthrough performance for the motherboard through efficient memory utilization. In Fixed mode, a fixed-size fragment of the system memory is allocated to the graphics core. In DVMT mode, the graphics driver allocates memory as needed for running graphics applications and is cooperatively using this memory with other system components. This item will not be used under Windows® Vista™ OS because the driver will intelligently detect physical memory available and allocate necessary video memory.

DVMT/FIXED Memory

You are allowed to adjust the shared memory size in this item if you set DVMT Mode Select as [DVMT Mode]. Configuration options: [128MB], [256MB] and [Maximum DVMT]. The option [Maximum DVMT] only appears when you adopt the memory module with 1024MB or above.

OnBoard HD Audio

Select [Auto], [Enabled] or [Disabled] for the onboard HD Audio feature. If you select [Auto], the onboard HD Audio will be disabled when PCI Sound Card is plugged.

Front Panel

Select [Auto], [Enabled] or [Disabled] for the onboard HD Audio Front Panel.

OnBoard Lan

This allows you to enable or disable the "OnBoard Lan" feature.

DRAM Voltage

Use this to select DRAM Voltage. Configuration options: [Auto], [1.72V],

[1.81V], [1.86V], [1.90V], [1.95V], [1.99V], [2.04V] and [2.13V]. The default value of this feature is [Auto].

NB Core Voltage

Use this to select Northbridge Core Voltage. Configuration options: [Auto], [Low] and [High]. The default value of this feature is [Auto].

VTT Voltage

Use this to select VTT Voltage. Configuration options: [Auto], [Low] and [High]. The default value of this feature is [Auto].

3.3.3 ACPI Configuration

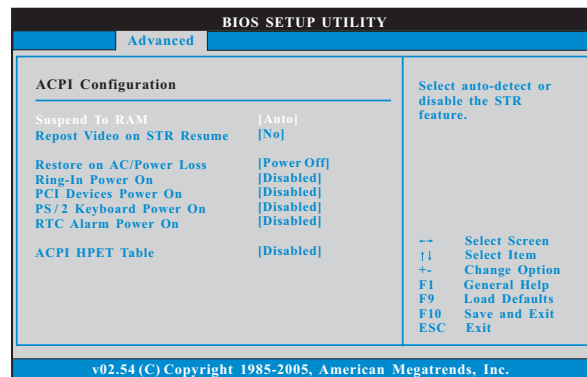

Suspend to RAM

Use this item to select whether to auto-detect or disable the Suspend-to-RAM feature. Select [Auto] will enable this feature if the OS supports it. If you set this item to [Disabled], the function "Repost Video on STR Resume" will be hidden.

Repost Video on STR Resume

This feature allows you to repost video on STR resume. (STR refers to suspend to RAM.)

Restore on AC/Power Loss

This allows you to set the power state after an unexpected AC/power loss. If [Power Off] is selected, the AC/power remains off when the power recovers. If [Power On] is selected, the AC/power resumes and the system starts to boot up when the power recovers.

Ring-In Power On

Use this item to enable or disable Ring-In signals to turn on the system from the power-soft-off mode.

PCI Devices Power On

Use this item to enable or disable PCI devices to turn on the system from the power-soft-off mode.

PS/2 Keyboard Power On

Use this item to enable or disable PS/2 keyboard to turn on the system from the power-soft-off mode.

RTC Alarm Power On

Use this item to enable or disable RTC (Real Time Clock) to power on the system.

ACPI HPET Table

Use this item to enable or disable ACPI HPET Table. The default value is [Disabled]. Please set this option to [Enabled] if you plan to use this motherboard to submit Windows® Vista™ certification.

3.3.4 IDE Configuration

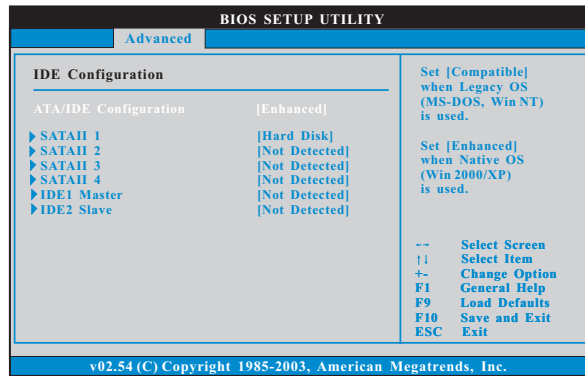

ATA/IDE Configuration

Please select [**Compatible**] when you install legacy OS (Windows® NT). If native OS (Windows® 2000 / XP) is installed, please select [**Enhanced**].

When [**Compatible**] is selected

Combined Option

It allows you to select between [**SATA 1, SATA 2, SATA 3, SATA 4**], [**SATA 1, SATA 3, IDE 1**], and [**IDE 1, SATA 2, SATA 4**]. If it is set to [SATA 1, SATA 3, IDE 1], then SATAII_2 and SATAII_4 will not work. Likewise, if it is set to [IDE 1, SATA 2, SATA 4], then SATAII_1 and SATAII_3 will not work.



Because Intel® ICH7 south bridge only supports four IDE devices under legacy OS (Windows® NT), you have to choose [SATA 1, SATA 2, SATA 3, SATA 4], [SATA 1, SATA 3, IDE 1], or [IDE 1, SATA 2, SATA 4] when the installed device is used with legacy OS.

	[SATA 1, SATA 2, SATA 3, SATA 4]	[SATA 1, SATA 3, IDE 1]	[IDE 1, SATA 2, SATA 4]
Master	SATAII_1, SATAII_2	SATAII_1	SATAII_2
Slave	SATAII_3, SATAII_4	SATAII_3	SATAII_4

IDE Device Configuration

You may set the IDE configuration for the device that you specify. We will use the "Primary IDE Master" as the example in the following instruction.

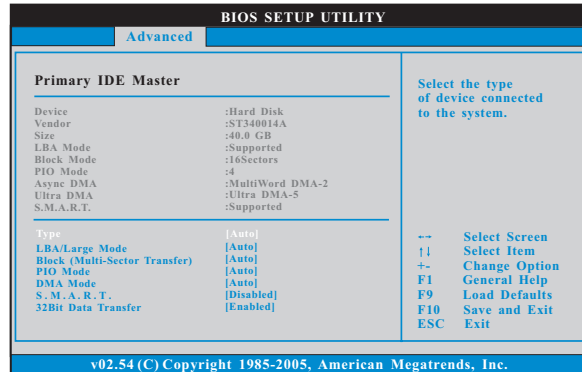

TYPE

Use this item to configure the type of the IDE device that you specify. Configuration options: [Not Installed], [Auto], [CD/DVD], and [ARMD].

[Not Installed]: Select [Not Installed] to disable the use of IDE device.

[Auto]: Select [Auto] to automatically detect the hard disk drive.



After selecting the hard disk information into BIOS, use a disk utility, such as FDISK, to partition and format the new IDE hard disk drives. This is necessary so that you can write or read data from the hard disk. Make sure to set the partition of the Primary IDE hard disk drives to active.

[CD/DVD]: This is used for IDE CD/DVD drives.

[ARMD]: This is used for IDE ARMD (ATAPI Removable Media Device), such as MO.

LBA/Large Mode

Use this item to select the LBA/Large mode for a hard disk > 512 MB under DOS and Windows; for Netware and UNIX user, select [Disabled] to disable the LBA/Large mode.

Block (Multi-Sector Transfer)

The default value of this item is [Auto]. If this feature is enabled, it will enhance hard disk performance by reading or writing more data during each transfer.

PIO Mode

Use this item to set the PIO mode to enhance hard disk performance by optimizing the hard disk timing.

DMA Mode

DMA capability allows the improved transfer-speed and data-integrity for compatible IDE devices.

S.M.A.R.T.

Use this item to enable or disable the S.M.A.R.T. (Self-Monitoring, Analysis, and Reporting Technology) feature. Configuration options: [Disabled], [Auto], [Enabled].

32-Bit Data Transfer

Use this item to enable 32-bit access to maximize the IDE hard disk data transfer rate.

3.3.5 PCI/PnP Configuration

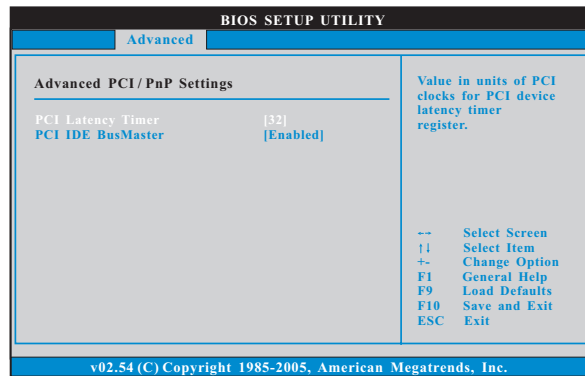

PCI Latency Timer

The default value is 32. It is recommended to keep the default value unless the installed PCI expansion cards' specifications require other settings.

PCI IDE BusMaster

Use this item to enable or disable the PCI IDE BusMaster feature.

3.3.6 Floppy Configuration

In this section, you may configure the type of your floppy drive.

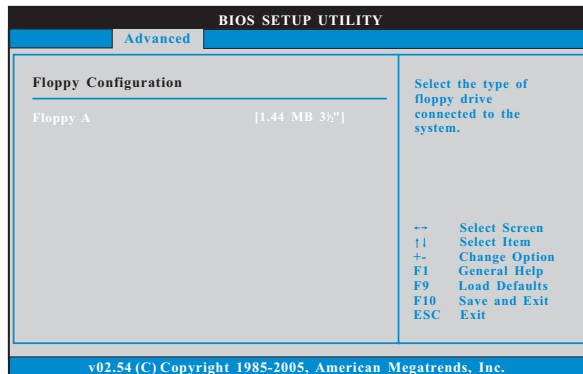

3.3.7 Super IO Configuration

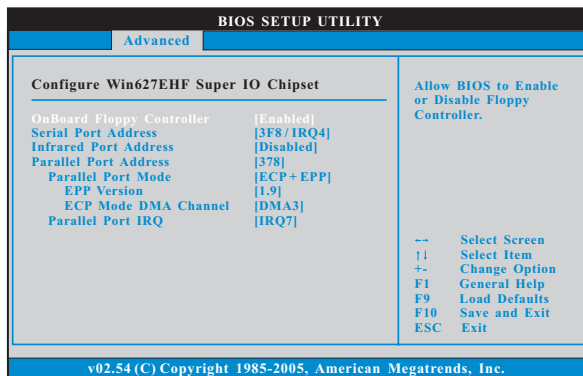

OnBoard Floppy Controller

Use this item to enable or disable floppy drive controller.

Serial Port Address

Use this item to set the address for the onboard serial port or disable it.

Configuration options: [Disabled], [3F8 / IRQ4], [2F8 / IRQ3], [3E8 / IRQ4], [2E8 / IRQ3].

Infrared Port Address

Use this item to set the address for the onboard infrared port or disable it.

Configuration options: [Disabled], [2F8 / IRQ3], and [2E8 / IRQ3]. If you plan to use ASRock DeskExpress on this motherboard, please keep this item on [Disabled] option.

Parallel Port Address

Use this item to set the address for the onboard parallel port or disable it. Configuration options: [Disabled], [378], and [278].

Parallel Port Mode

Use this item to set the operation mode of the parallel port. The default value is [ECP+EPP]. If this option is set to [ECP+EPP], it will show the EPP version in the following item, "EPP Version". Configuration options: [Normal], [Bi-Directional], and [ECP+EPP].

EPP Version

Use this item to set the EPP version. Configuration options: [1.9] and [1.7].

ECP Mode DMA Channel

Use this item to set the ECP mode DMA channel. Configuration options: [DMA0], [DMA1], and [DMA3].

Parallel Port IRQ

Use this item to set the IRQ for the parallel port. Configuration options: [IRQ5] and [IRQ7].

3.3.8 USB Configuration

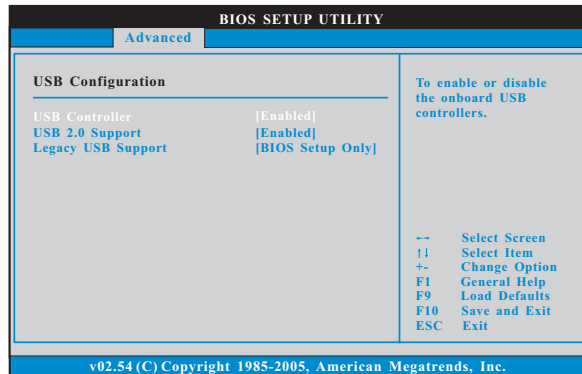

USB Controller

Use this item to enable or disable the use of USB controller.

USB 2.0 Support

Use this item to enable or disable the USB 2.0 support.

Legacy USB Support

Use this option to select legacy support for USB devices. There are four configuration options: [Enabled], [Auto], [Disabled] and [BIOS Setup Only]. The default value is [BIOS Setup Only]. Please refer to below descriptions for the details of these four options:

[Enabled] - Enables support for legacy USB.

[Auto] - Enables legacy support if USB devices are connected.

[Disabled] - USB devices are not allowed to use under legacy OS and BIOS setup when [Disabled] is selected. If you have USB compatibility issue, it is recommended to select [Disabled] to enter OS.

[BIOS Setup Only] - USB devices are allowed to use only under BIOS setup and Windows / Linux OS.

3.4 Hardware Health Event Monitoring Screen

In this section, it allows you to monitor the status of the hardware on your system, including the parameters of the CPU temperature, motherboard temperature, CPU fan speed, chassis fan speed, and the critical voltage.

BIOS SETUP UTILITY					
Main	Advanced	H/W Monitor	Boot	Security	Exit
Hardware Health Event Monitoring			Enable/Disable CPU Quiet Fan Function.		
CPU Temperature	:	37°C / 98°F			
M/B Temperature	:	31°C / 87°F			
CPU Fan Speed	:	3400 RPM			
Chassis Fan Speed	:	N/A			
Vcore	:	1.629V			
+ 3.30V	:	3.306V			
+ 5.00V	:	5.067V			
+ 12.00V	:	11.890V			
CPU Quiet Fan	:	[Disabled]	-- Select Screen		
			↑ Select Item		
			F1 General Help		
			F9 Load Defaults		
			F10 Save and Exit		
			ESC Exit		

v02.54 (C) Copyright 1985-2003, American Megatrends, Inc.

CPU Quiet Fan

This item allows you to identify the temperature of CPU fan. If you set this option as [Disabled], the CPU fan will operate in full speed. If you set this option as [Enabled], you will find the items "Target CPU Temperature" and "Target Fan Speed" appear to allow you adjusting them. The default value is [Disabled]. You are allowed to enable this function only when you install 4-pin CPU fan.

Target CPU Temperature

The target temperature will be between 45°C/113°F and 65°C/149°F. The default value is [50°C/122°F].

Target Fan Speed

Use this option to set the target fan speed. You can freely adjust the target fan speed according to the target CPU temperature that you choose. Configuration options: [Fast], [Middle] and [Slow].

3.5 Boot Screen

In this section, it will display the available devices on your system for you to configure the boot settings and the boot priority.

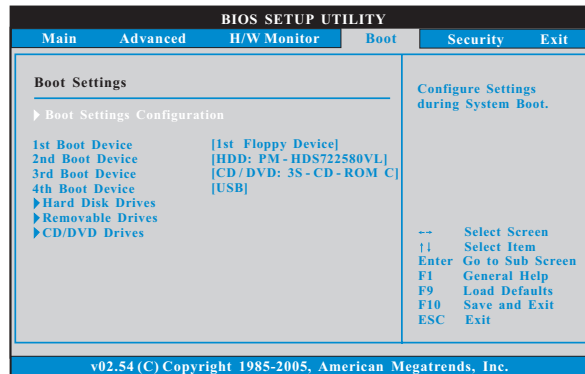

3.5.1 Boot Settings Configuration

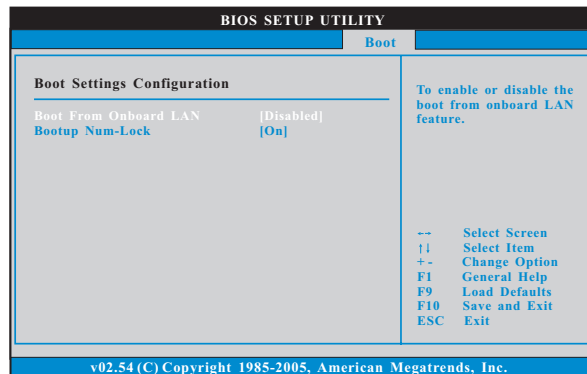

Boot From Onboard LAN

Use this item to enable or disable the Boot From Onboard LAN feature.

Boot Up Num-Lock

If this item is set to [On], it will automatically activate the Numeric Lock function after boot-up.

3.6 Security Screen

In this section, you may set or change the supervisor/user password for the system. For the user password, you may also clear it.

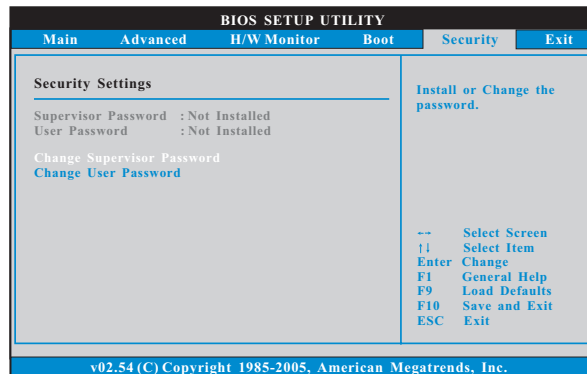

3.7 Exit Screen

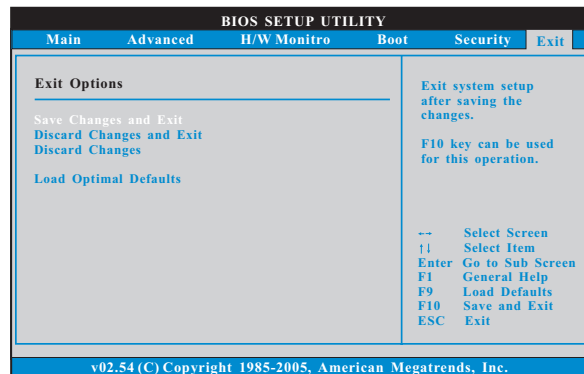

Save Changes and Exit

When you select this option, it will pop-out the following message, “Save configuration changes and exit setup?” Select [OK] to save the changes and exit the BIOS SETUP UTILITY.

Discard Changes and Exit

When you select this option, it will pop-out the following message, “Discard changes and exit setup?” Select [OK] to exit the BIOS SETUP UTILITY without saving any changes.

Discard Changes

When you select this option, it will pop-out the following message, “Discard changes?” Select [OK] to discard all changes.

Load Optimal Defaults

When you select this option, it will pop-out the following message, “Load optimal defaults?” Select [OK] to load the default values for all the setup configurations.

Chapter 4 Software Support

4.1 Install Operating System

This motherboard supports various Microsoft® Windows® operating systems: 2000 / XP / XP 64-bit / Vista™ / Vista™ 64-bit. Because motherboard settings and hardware options vary, use the setup procedures in this chapter for general reference only. Refer to your OS documentation for more information.

4.2 Support CD Information

The Support CD that came with the motherboard contains necessary drivers and useful utilities that enhance the motherboard features.

4.2.1 Running The Support CD

To begin using the support CD, insert the CD into your CD-ROM drive. The CD automatically displays the Main Menu if "AUTORUN" is enabled in your computer. If the Main Menu did not appear automatically, locate and double click on the file "ASSETUP.EXE" from the BIN folder in the Support CD to display the menus.

4.2.2 Drivers Menu

The Drivers Menu shows the available devices drivers if the system detects installed devices. Please install the necessary drivers to activate the devices.

4.2.3 Utilities Menu

The Utilities Menu shows the applications software that the motherboard supports. Click on a specific item then follow the installation wizard to install it.

4.2.4 Contact Information

If you need to contact ASRock or want to know more about ASRock, welcome to visit ASRock's website at <http://www.asrock.com>; or you may contact your dealer for further information.